

**DOWNTOWN LITTLETON**

# **HISTORIC PRESERVATION DESIGN GUIDELINES**

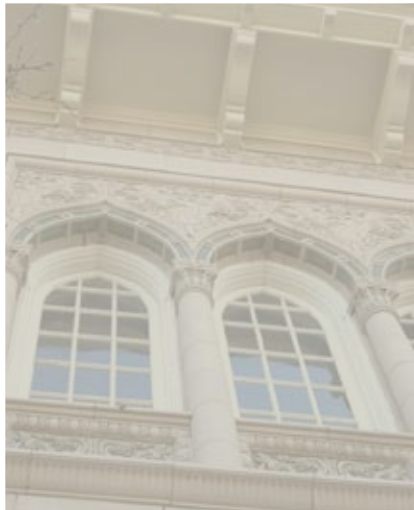

**A SUPPLEMENT TO THE DOWNTOWN DESIGN  
STANDARDS AND GUIDELINES**

**JULY 6, 2011**

# CREDITS

## City of Littleton Community Development Department

Glen Van Nimwegen, Director  
Jan Dickinson, Principal Planner  
Dennis Swain, Senior Planner  
Ernie Rose, Senior Planner  
Andrea Mimnaugh, Senior Planner  
Pam Hall, Zoning Official  
Mark Barons, Neighborhood Resources Coordinator  
Doreen Wilson, Administrative Coordinator

## Historical Preservation Board

Margi Clute  
Stephen Ekman  
Pamela Grove  
William Hopping  
Paul Kastner  
Kevin Koernig, Chairman  
Katherine McMurray  
Daniel Murphy  
Chuck Reid, Vice Chair

## Special Thanks to:

A special thank you to all the residents, property owners, tenants and interested persons who participated in the workshops and public hearings during the design guidelines process.

## Photos:

Note that some images are used to illustrate the character of Littleton, and are not intended to indicate the status of these properties as historic resources. Also note that some images from other communities are included to illustrate appropriate design solutions.

## Prepared by:

**Winter & Company**  
1265 Yellow Pine Avenue  
Boulder CO 80304  
303.440.8445  
*[www.winterandcompany.net](http://www.winterandcompany.net)*

**This document is a supplement of the Downtown Design Standards and Guidelines.**

# TABLE OF CONTENTS

<b>Introduction</b>	<b>i</b>
Applicability of the Historic Preservation Design Guidelines	ii
Using the Preservation Design Guidelines	iii
Relationship to the Secretary of the Interior's Standards for Rehabilitation	viii
<b>I. Historic Character and Property Types of Downtown Littleton</b>	<b>1</b>
The Historic Character of Downtown Littleton	2
Definition of Key Terms	5
Styles	8
<b>II. General Principles of Historic Preservation</b>	<b>15</b>
What Does Preservation Mean?	16
Sustainability and Historic Buildings	19
Preservation Principles	25
Planning a Preservation Project	27
Determining the Appropriate Treatment for a Property	31
Flexibility and Facade Treatments	34
<b>III. Design Guidelines for Historic Properties</b>	<b>35</b>
Solutions for the Treatment of Individual Building Components	36
Solutions for Additions to Historic Buildings	53
Solutions for Historic Site Features	58
Solutions for Sustainability	59



# INTRODUCTION

Littleton’s historic buildings have helped shape the unique identity of the community and are a source of civic pride regarding the past, and the future, providing residents with a sense of community that is more and more often sought in today’s world.

Citizens and property owners have recognized that the character of downtown is an asset. It is their goal that downtown continues to develop in a coordinated manner so that its character is maintained. This document provides guidance for improving historic properties within Downtown Littleton. The guidelines will help residents and property owners in understanding the historic character of downtown and assist owners when planning repair, maintenance and rehabilitation projects. This chapter explains the basic organization and function of the preservation guidelines document.

## IN THIS CHAPTER:

Applicability of the Historic Preservation Design Guidelines	ii
Using the Preservation Design Guidelines	iii
What are Design Guidelines?	iii
Why Have Design Guidelines?	iii
Building Project Tracks	iii
Components of a Design Guideline	vi
Terms Related to Compliance	vii
Relationship to the Secretary of the Interior’s Standards for Rehabilitation	viii



*Downtown Littleton retains many of its original buildings and much of the charm of its human-scaled pedestrian character.*



## APPLICABILITY OF THE HISTORIC PRESERVATION DESIGN GUIDELINES

This document serves as a special supplemental chapter to the City’s Downtown Design Standards and Guidelines, which were adopted in 2006. This document applies specifically to properties within the Main Street Historic District designated as “contributors,” as well as buildings outside the district that are individually landmarked. Owners of properties on the List of Merit are also encouraged to use these guidelines. For new buildings and alterations to non-contributing buildings within the Main Street Historic District, the Downtown Design Standards and Guidelines will continue to be used.

*The guidelines in this document apply to properties within the opt-in Main Street Historic District, as well as buildings outside the district that are individually landmarked. Owners of properties on the List of Merit are also encouraged to use these guidelines.*

This document contains the primary guidelines for historic properties; however, other guidelines in the Downtown Design Standards and Guidelines document may also apply. The policies set forth in this document are consistent with the more general statements within the Downtown Design Standards and Guidelines. Note that in some cases, similar material may appear both within this chapter as well as elsewhere in the Downtown Design Standards and Guidelines. In those cases, this document provides more detailed guidance and should prevail.

### RELATIONSHIP OF CITY REGULATIONS

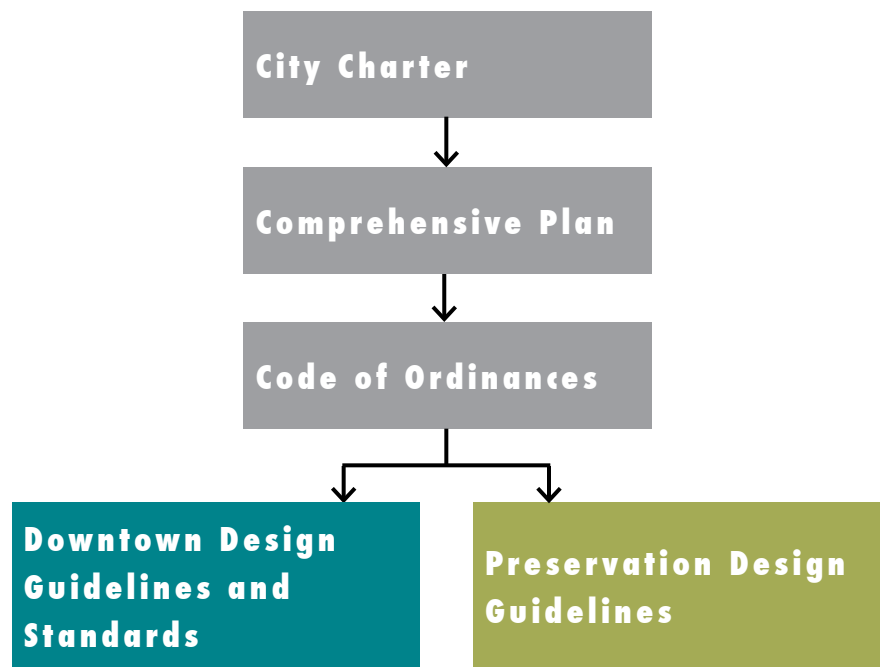

*This table diagrams the relationship of the City’s regulatory documents, and their relationship with these design guidelines.*

## USING THE PRESERVATION DESIGN GUIDELINES

The decision-making tools in this section may be used to determine more specifically which guidelines apply to an individual improvement project.

### WHAT ARE DESIGN GUIDELINES?

Design guidelines convey general policies about the rehabilitation of existing structures, additions and site work. They do not dictate solutions; instead, they define a range of appropriate responses to a variety of specific design issues. They provide a direction for treatment of historic buildings, alterations to other existing structures and the design of additions and new buildings.

### WHY HAVE DESIGN GUIDELINES?

The primary purpose of the guidelines, and the review process through which they are administered, is to promote preservation of the historic, cultural and architectural heritage of Downtown Littleton. The design guidelines provide a basis for making consistent decisions about the treatment of historic resources. An essential idea is to protect historic resources in the downtown from alteration or demolition that might damage the unique fabric of the core of the city. By promoting preservation, the guidelines also support the social, environmental and economic wellbeing of the city (see page 19).

In addition, the design guidelines also serve as an educational and planning tool for property owners and their design professionals who seek to make improvements. While the guidelines are written for use by the layperson, property owners are strongly encouraged to enlist the assistance of qualified design and planning professionals, including architects and preservation consultants.

### BUILDING PROJECT TRACKS

There are two major “project tracks” in the design guidelines: (1) the New Construction Track and (2) the Historic Track. Use the following flow chart to determine which track applies to a specific building project.



*For topics not addressed in these design guidelines see Community Development Staff and the Downtown Design Standards and Guidelines.*

## WHICH TRACK SHOULD MY PROJECT FOLLOW?

Follow the steps below to determine your project track.

### STEP 1 Does the building project involve an existing building?

If the project involves an existing building, proceed to question 2. If the project is a new building on a vacant site, the new construction track applies; follow the Downtown Design Standards and Guidelines.

### STEP 2 What is the significance of the building?

If the building is historic or contributing, the historic building track should be used; follow the Historic Preservation Design Guidelines and the Downtown Design Standards and Guidelines. If the building is non-contributing skip to question 3. The City will work with a property owner to confirm the status of historic significance.

#### Contributing Property

A “contributing” property is one determined to be historically significant. It is so because it was present during the period of significance for Littleton and possesses sufficient integrity to convey its history, or is capable of yielding important information about that period. Note that a contributing property may have experienced some degree of alteration from its original design, yet retains sufficient building fabric to still be considered contributing.

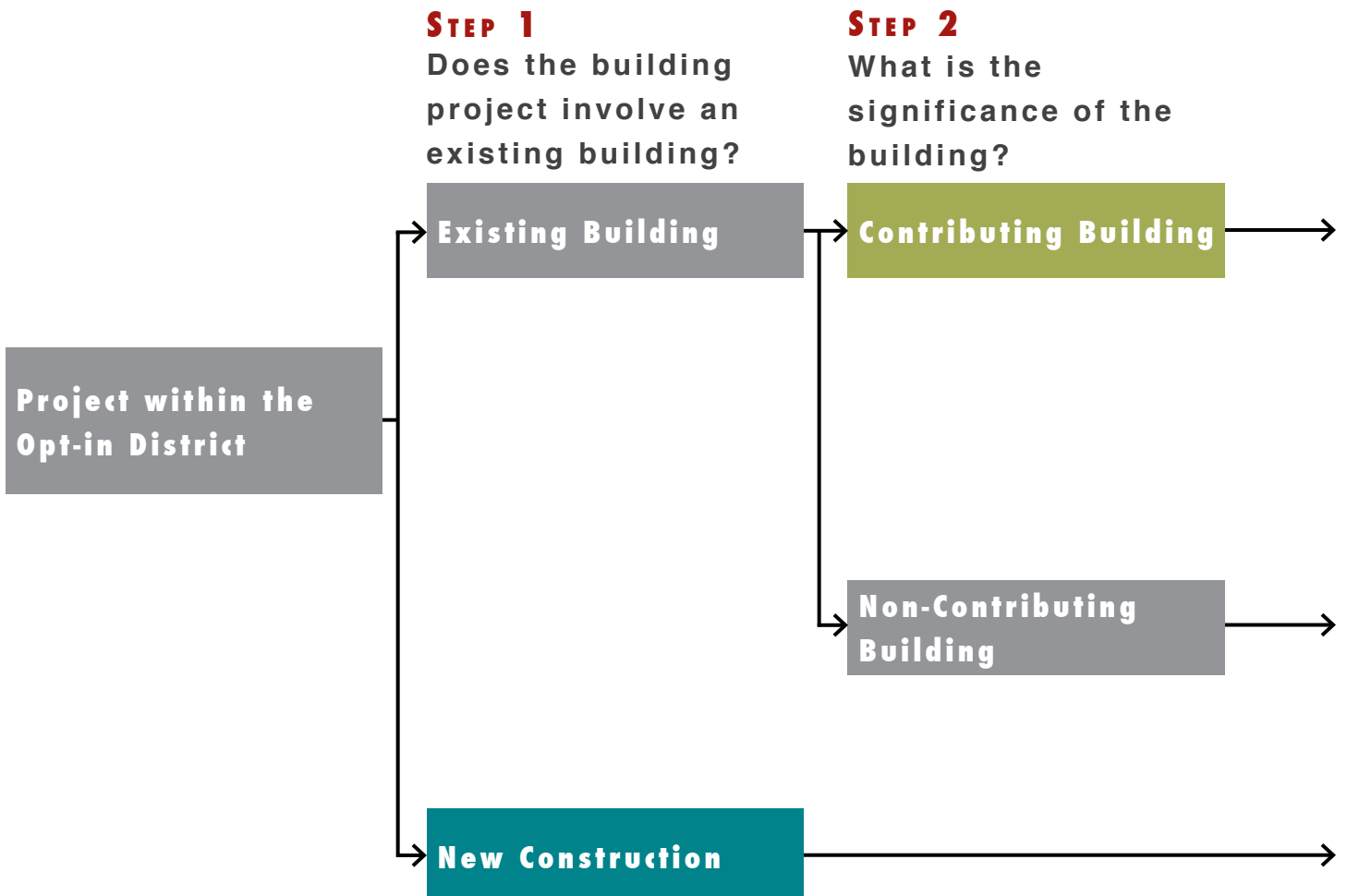



**STEP 3** How do I treat an existing building that is non-contributing?

If it is an existing building that has not achieved significance, follow the Downtown Design Standards and Guidelines.

If the building was previously significant, but has been altered such that it has lost its historic significance, there are two options depending on the extent of the alterations and the desired project:

**Option A: Non-Contributing, Restorable**

If the alterations are such that the building may be restored, the historic track may be followed, but is the owner’s decision and not required. In this case follow the Historic Preservation Design Guidelines.

**Option B: Non-Contributing**

If the alterations are so extensive that it is not possible to restore the historic integrity of the property, or if the owner wishes, the New Construction Track may be used. In this case follow the Downtown Design Standards and Guidelines.

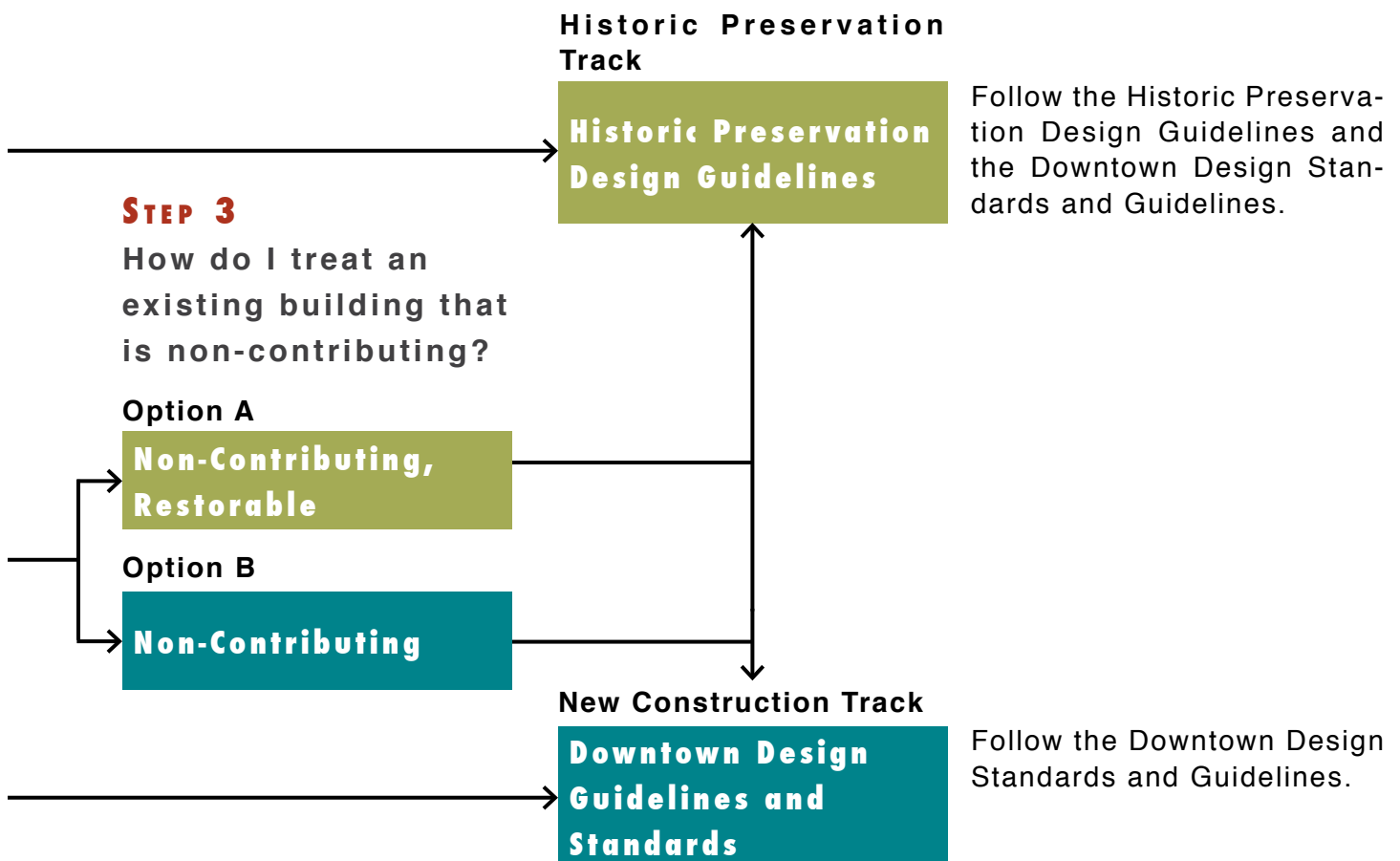

## COMPONENTS OF A DESIGN GUIDELINE

Each design guideline, as illustrated on the following page, contains the following components:

### A Design Element

The first is the design element category (e.g., streetscape elements, site planning, building materials and secondary structures) under which the design guideline falls.

### B Policy Statement

Second is a **policy statement** explaining the City's basic approach to treatment of the design element. This is the basis for the more detailed design guidelines that follow.

### C Design Guidelines

Third is the design guideline statement itself, which is typically performance-oriented, describing a desired design treatment. It is numbered to facilitate referencing.

### D Additional Information

The design guideline statement is followed by supplementary information that is treated as sub-points of the guideline.

### E Illustration

A design guideline is further explained with photographs and illustrations. Many images illustrate appropriate treatments. The images used should not be considered the only appropriate options, but as examples of some possible approaches.

## DETAIL OF DESIGN GUIDELINE COMPONENTS

### A → WINDOWS

#### B → Treatment of Historic Windows

The character-defining features of a historic window, its distinct materials and its placement should be preserved.

#### C → 3.1 Preserve the functional and decorative features of a historic window.

- D → • See the following diagrams for an illustration of window features.
- Repair frames and sashes rather than replacing them, whenever possible.

### E →



*The character-defining features of a historic window should be preserved.*

## TERMS RELATED TO COMPLIANCE

When applying design guidelines, the City balances a combination of objectives and intent statements that appear throughout the document in the interest of helping to achieve the most appropriate design for each project. Because of this, and the fact that the design guidelines are also written to serve an educational role, the language sometimes appears more conversational than that in the Littleton Zoning Ordinance. To clarify how some terms are used, these definitions shall apply:

### Guideline

In this document the term “guideline” is a criterion with which the City will require compliance, when it is found applicable to the specific proposal. In this sense it is a standard, albeit one that is subject to some interpretation when determining compliance.

### Shall

Where the term “shall” is used, compliance is specifically required, when the statement is applicable to the proposed action.

### Should

The term “should” is frequently used in the guidelines. This indicates that compliance is expected, except in conditions in which the City finds that the guideline is not applicable, or that an alternative means of meeting the intent of the guideline is acceptable. In this sense, “should” means “shall.”

### May be Considered

The phrase “may be considered” appears in some guidelines text. This indicates that the City has the discretion to determine if the action being discussed is appropriate. This decision is made on a case-by-case basis, using the information specifically related to the project and its context.





## **RELATIONSHIP TO THE SECRETARY OF THE INTERIOR'S STANDARDS FOR REHABILITATION**

The Secretary of the Interior's (SOI) Standards for the Rehabilitation of Historic Buildings are established by the National Park Service. These are widely used as a foundation for local preservation guidelines. It is the intent of the guidelines for Downtown Littleton to be consistent with the SOI's Standards. In this way, property owners who may seek special incentives and benefits, such as tax credits, may do so when complying with the downtown guidelines. However, in some cases, Littleton's guidelines may be more permissive than the way in which the SOI's standards may be used by state and federal agencies in some applications, but the City's guidelines will not create a conflict.

# I. HISTORIC CHARACTER AND PROPERTY TYPES OF DOWNTOWN LITTLETON

This chapter provides a brief description, using photographs and diagrams, of the key architectural features that are found on the typical building types and styles located in Downtown Littleton. These diagrams should be used by owners to help identify the key features of their properties that should be preserved. Conversely, by inference, those features that are not significant can be identified as locations where more flexibility in design options may be available.



*Photo courtesy of the Littleton Museum.*

## IN THIS CHAPTER:

The Historic Character of Downtown Littleton	2
A Vision for the Historic District	3
The Main Street Historic District Opt-in Boundary	4
Definition of Key Terms	5
Glossary	6
<b>Styles</b>	<b>8</b>
Art Moderne	9
19th Century Commercial- Italianate Styling	10
Early 20th Century Commercial	11
Italian Renaissance/Renaissance Revival	12
Mission Revival	13
Vernacular Residential	14



## THE HISTORIC CHARACTER OF DOWNTOWN LITTLETON

The Littleton Main Street Historic District lies in the heart of downtown and contains the greatest concentration of commercial buildings with historic significance in the area. The bulk of the properties within the opt-in district lie along Main Street, although some are located along streets immediately adjacent.

Most buildings have simple rectilinear forms, which reflect the layout of parcels in the area. The majority of the buildings are of a traditional commercial storefront type. That is, they have large display windows at the street level, and entrances are recessed. These buildings are constructed along the inside sidewalk edge, which creates a clearly defined street wall. Because many of the storefronts were constructed to relatively similar heights, a horizontal alignment of “transparency” exists at the street level.

Above the first floors, cornice lines vary; many structures are one story in height, and these create a relatively consistent line in some blocks, but several two-story buildings also are found, sometimes in sets as well. In the upper floors of these structures, windows are vertically proportioned and generally align along the block, with stone sills and decorative belt courses that emphasize this alignment. These features contribute to the visual continuity of the district.

This combination of one and two story facades creates a relatively low scale street edge, but with variations in height; this is a key feature of the area. Masonry, particularly brick, is the predominant building material, although stone and stucco also appear on some historic structures.

While traditional commercial storefronts provide the basic framework for the district, other building types do exist, which serve as accents within this context. The Old Town Hall is an example. A row of three gothic arches defines the street level, with a wall of doors and windows that is recessed. Down the street, the historic Carnegie Library stands apart, as many civic and institutional buildings have done traditionally. It relates to the district, in terms of masonry materials and overall scale and use of details, but it is meant to be perceived “in the round,” with all sides conveying a level of detail that is less frequently seen on the sides or rear elevations of traditional commercial storefronts.

*In addition to being a local historic district, Downtown Littleton is listed as a National Register Historic District. The National Register boundaries for the Littleton Main Street Historic District include the north side of Main Street on the 2300 block, and both sides of the 2400 and 2500 blocks. See the Community Development Department for more information on the National Register listing.*

In addition, a collection of residential structures exists along West Alamo Avenue. Most are now converted to commercial uses, but retain key characteristics of their historic designs: Building fronts are set back from the street, with small yards. Fences define the front property lines. Shade trees and shrubs add color and texture.

Gable roofs are typical, usually oriented perpendicular to the street. Eave overhangs provide distinctive shadow lines. Some have dormers in the roof forms, which add visual interest and reduce perceived building mass.

Entrances face the street, and are defined with raised porches, which span the entire width of the building front. Masonry and wood siding are primary building materials.

When considered all together, the collection of historic buildings within the opt-in district are diverse in characteristics, but are within a relatively narrow range of building types and styles that reflect the early history of Downtown Littleton. It is this rich collection of historic resources that defines the heart of downtown.



Photo courtesy of the Littleton Museum.

See the Community Development Department for current information on the Downtown Area Plan.

## A VISION FOR THE HISTORIC DISTRICT

The city's draft *Downtown Area Plan* describes a vision of the downtown in general, which includes this statement:

*“Those elements of the Downtown Area’s built environment that are essential to Littleton’s unique sense of place and identity will be preserved, while reinvestment and compatible redevelopment that will enhance Littleton’s economic vitality are encouraged.”*

The *Downtown Area Plan* further outlines policies related to preservation that are relevant to the Main Street Historic District:

*“Policy #1c: The Downtown Historic District and the Louthan Heights Historic District will be maintained and enhanced as important tools for protecting and improving the character of the Downtown Area.”*

The design guidelines in this document are intended to help implement that vision and policy statement.

The properties shown within the Main Street Historic District are current as of the publication of this document. See Community Development Staff for a current list of properties within the district.

## THE MAIN STREET HISTORIC DISTRICT

The properties shown on the map below as within the Main Street Historic District are current as of the publication of this document. See Community Development Staff for a current list of properties within the district.

### MAIN STREET HISTORIC DISTRICT

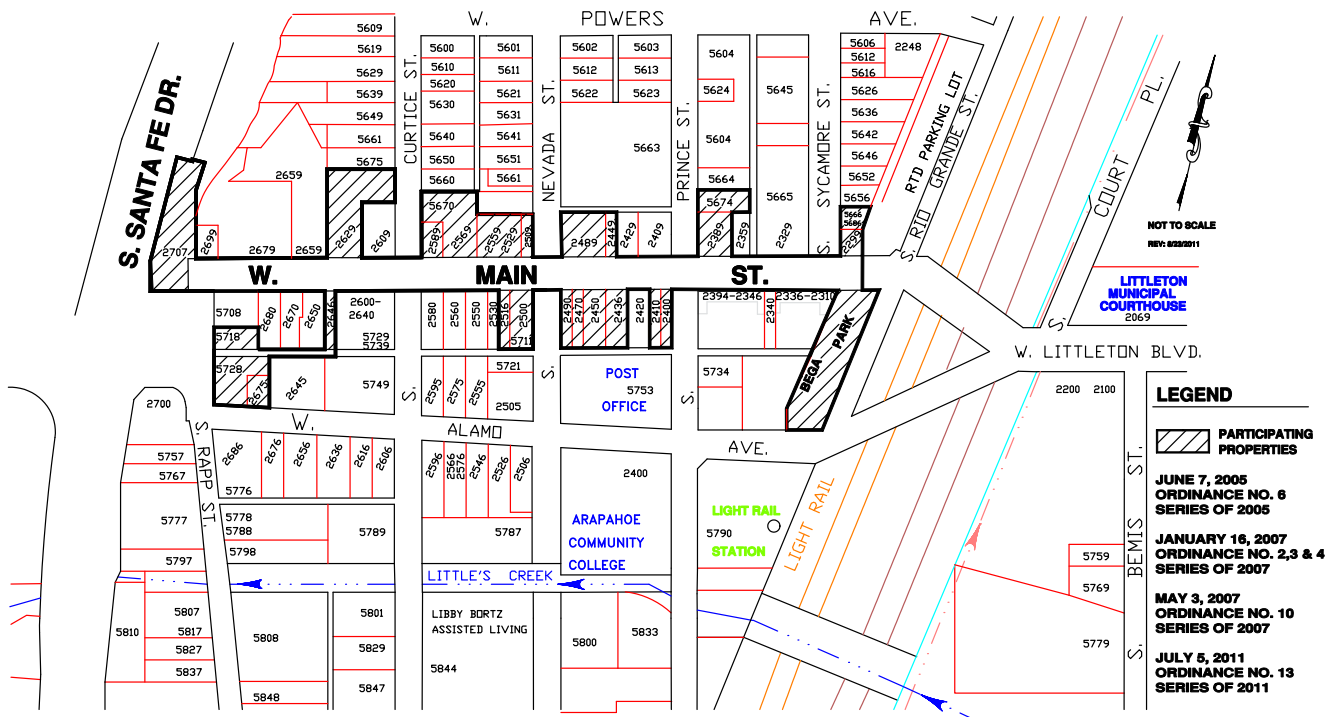



## DEFINITION OF KEY TERMS

The following diagrams represent typical historic buildings in Downtown Littleton, with their key architectural elements called out. Following these diagrams are definitions of these and other common character-defining features of historic buildings.

### CHARACTER-DEFINING ELEMENTS OF A COMMERCIAL FACADE WITH STOREFRONT

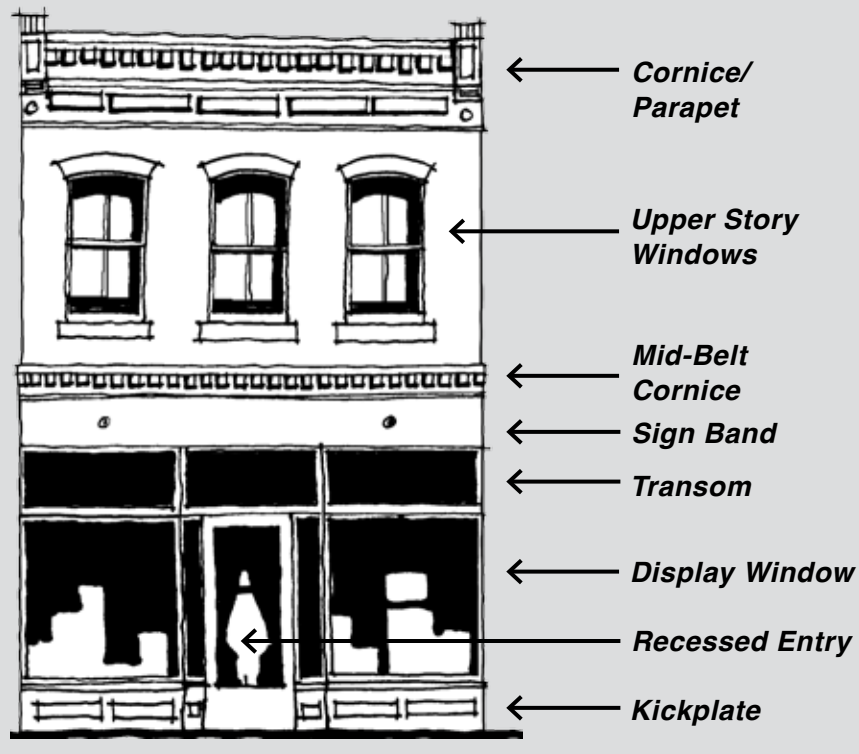

*This commercial building in Downtown Littleton has many typical elements of a storefront (see diagram at left).*

*Diagram 1: Components of a commercial building facade with storefront.*

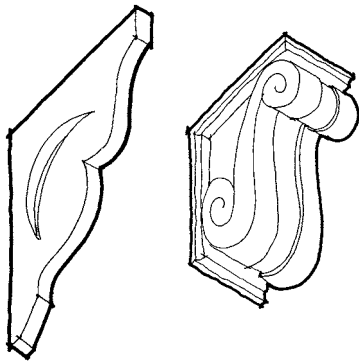

Figure 1: Bracket

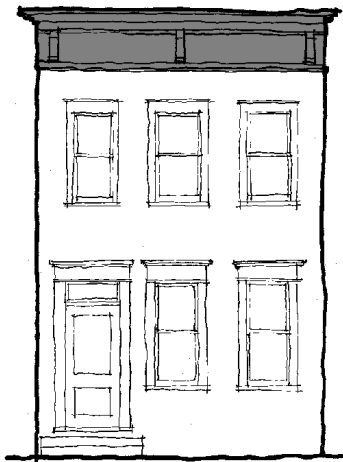

Figure 2: Cornice

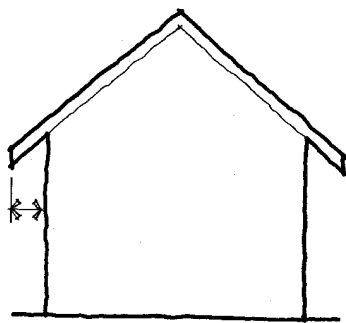

Figure 3: Eave

## CHARACTER-DEFINING ELEMENTS OF A RESIDENTIAL FACADE

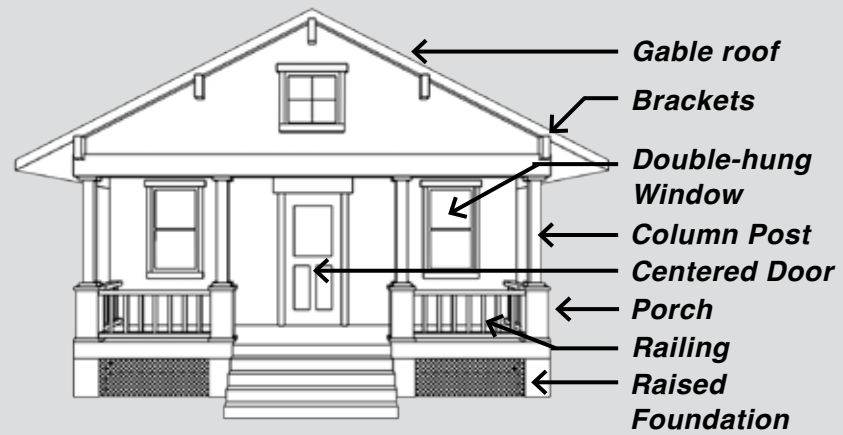

Diagram 2: Components of a traditional residential building facade.

## GLOSSARY

### Belt Course

A horizontal board across or around a building usually enhanced with decorative molding.

### Bracket

A supporting member for a projecting element or shelf, sometimes in the shape of an inverted L and sometimes as a solid piece or a triangular truss (see figure 1).

### Canopy

A roof like projection or shelter that projects from the facade of a building over the sidewalk.

### Cornice

The top course or molding of a wall when it serves as a crowning member (see figure 2).

### Cornice Molding

A decorative band at the top of the building.

### Display Window

The main portion of glass on the storefront, where goods and services are displayed.

### Eave

The underside of a sloping roof projecting beyond the wall of a building (see figure 3).

**Fascia**

A flat board with a vertical face that forms the trim along the edge of a flat roof, or along the horizontal, or “eaves,” sides of a pitched roof. The rain gutter is often mounted on it.

**Gable**

The portion, above eave level, of an end wall of a building with a pitched or gambrel roof. In the case of a pitched roof this takes the form of a triangle. The term is also used sometimes to refer to the whole end wall.

**Kickplate**

Found beneath the display window. Sometimes called a bulk-head panel (see figure 4).

**Mid-belt Cornice**

A decorative band at the top of the first floor.

**Molding**

A decorative band or strip of material with a constant profile or section designed to cast interesting shadows. It is generally used in cornices and as trim around window and door openings (see figure 5).

**Parapet**

An upward extension of a building wall above the roofline, sometimes ornamented and sometimes plain, used to give a building a greater feeling of height or a better sense of proportion (see figure 6).

**Sign Band**

A flat band running above the transoms to allow for the placement of signs.

**Sill**

The lowest horizontal member in a frame or opening for a window or door. Also, the lowest horizontal member in a framed wall or partition.

**Storefront (Commercial Storefront)**

Exterior facade of a commercial building. Includes the following architectural elements: display window, transom, kickplate, entry, cornice molding, and upper story windows.

**Transom Window**

A small window or series of panes above a door, display window or above a casement or double hung window.

**Upper-story Windows**

Windows located above the street level often have a vertical orientation.



Figure 4: Kickplate

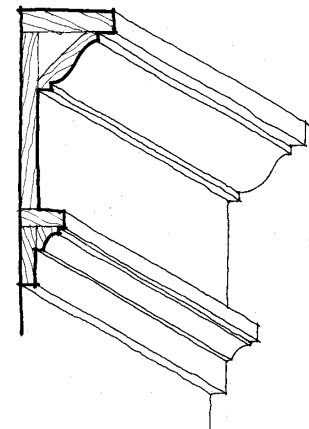

Figure 5: Molding

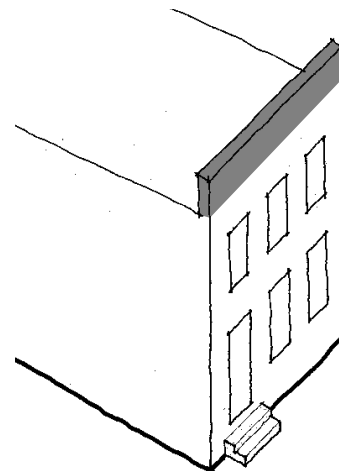

Figure 6: Parapet



*Photo courtesy of the Littleton Museum.*

*See the Community Development Department for assistance finding information on specific historic properties.*

## STYLES

This section defines Downtown Littleton’s most common historic architectural styles. Photographs are provided to illustrate these styles and their character-defining features. Note, however, that styles are rarely “pure” in form, and there are a wide range of variants that may exist within individual styles. It may also be that alterations or additions have occurred, resulting in features which are not characteristic of the style of the building.

Many of the guidelines in this document refer to the character defining features of a historic building. This section will assist the City’s design review authority in determining the significance and appropriate treatment for a building.

### Styles illustrated include:

- Art Moderne
- 19th Century Commercial- Italianate Styling
- Early 20th Century Commercial
- Italian Renaissance/Renaissance Revival
- Mission Revival
- Vernacular Residential

## ART MODERNE

(c. 1930-1940)

Often closely related to the International Style in appearance, the Art Moderne was devised as a way of incorporating the machine aesthetic into architecture, in the sense that buildings could emulate motion and efficiency. It is also referred to as the Streamlined Moderne, and always carried the aura of the futuristic. Whatever the term, in this case architecture followed industrial design, as “the slick look” was used for everything from irons to baby carriages. It is characterized by unbroken horizontal lines and smooth, curving display windows.

### Characteristics

- Smooth wall surfaces
- Rounded corners
- Flat roof
- Canopy
- Use of glass block
- Use of metal sash windows
- Horizontal bands at the cornice
- Metal doors with large panels of glass



### Sample Key Features:

*Horizontal banding at cornice line*

*Metal sash windows*

*Glass block*

*Cantilevered curved canopy*

*Curved wall feature*

## 19TH CENTURY COMMERCIAL-ITALIANATE STYLING

(c. 1870-1895)

The 19th Century commercial style buildings are often two stories. A glass storefront is located at the street level and windows punctuate the facade on the upper level. These buildings typically have single or double storefronts. Italianate detailing is prevalent on these facades. This includes projecting cornices, supported by large brackets.

### Characteristics

- Brick, wood clapboard, plaster
- Ornate treatment of the cornice, including the use of large brackets, modillions and dentil courses
- Glassed storefront with kickplate, display windows and transom features
- Recessed entry, corner buildings may have corner entrance
- Double-hung, narrow windows, with lintels (these are sometimes rounded)
- Window panes are either one-over-one or two-over-two
- Protruding sills



### Sample Key Features:

*Decorative cornice with brackets*

*Double-hung windows with sill band*

*Awning mounted along top of transom windows*

*Large plate glass display windows*

*Recessed entry*

*Kickplate*



## EARLY 20TH CENTURY COMMERCIAL

(c. 1900-1950)

The Early 20th Century Commercial style buildings are typically one to four stories. Buildings are divided horizontally into two distinct bands. The street level is more commonly transparent, so goods can be displayed, while the second story is usually reserved for residential, office or storage space. The upper floor is typically supported by a steel beam that spans the glass opening. However, many one-story examples also exist. A kickplate is found below the display window while above the display window, a smaller band of glass, a transom, is seen. Also, the main door is frequently recessed.

Ornamental detail exists, but is simple, limited to a shallow molding such as a cornice.

### Characteristics

- Brick; sometimes blond in color, wood clapboard, plaster
- Glased storefront with kickplate, display windows and transom features
- Recessed entry
- Simple cornice, often corbeled
- Double-hung, narrow windows, sometimes with lintels
- Window panes are either one-over-one or two-over-two
- Protruding sills



*The building shown above is a successful rehabilitation.*



*The building shown above is a rehabilitation opportunity. It retains many of its key features.*



### Sample Key Features:

***Cornice with simple details, including recessed panels and corbeling***

***Continuous Lintel  
Transom***

***Display Window***

***Kickplate***

*Many of the key features are still retained on this building; however, it appears the storefront was replaced with a compatible contemporary interpretation of a storefront.*



## ITALIAN RENAISSANCE / RENAISSANCE REVIVAL

(c. 1890-1930)

These buildings are often formal/symmetrical in form with ornamental embellishments. There are less ornate examples.

### Characteristics

- Horizontal division
- Ashlar block
- Arcade
- Decorative window and door moldings
- Quoins
- Ornate treatment of the cornice, including the use of brackets, modillions and dentil courses
- Multiple window divisions
- Transom, often curved, above the front door

### Sample Key Features:

*Projecting cornice*

*Decorative window moldings*

*Smooth ashlar*

*Curved openings*

*Supporting columns*



*Embellished moldings*

*Quoins*

*Balconettes*

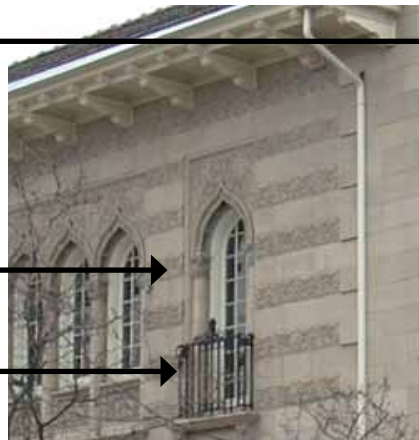



## MISSION REVIVAL

(c. 1920-1940)

The Mission Revival was an influential revival style found in Colorado during the 1920s and 1930s. This style was popularized by the Panama-California Exposition, held in San Diego in 1915. The exposition was widely publicized, and the use of architectural examples from the Spanish Colonies encouraged Americans to realize that their country had a rich Spanish heritage, as well as an Anglo-Saxon past. Architects were also influenced by the baroque architecture of Mexico and Spain.

### Characteristics

- Low-pitched roof with Spanish tile (little or no eaves extension) or flat roof with parapet (some with tile coping)
- Flat stucco walls with smooth or textured finish
- Decorative wall surfaces, using tile or low-relief terracotta sculpture
- Round-arched openings
- Recessed windows and doors
- Wood casement windows often in groups, especially on the front elevation (prominent windows) on front may have wood or wrought iron grill or classical ornamentation)
- Decorative details that might include wrought-iron for balcony and porch railings, quatrefoil window, buttressed corners



*Round-arched openings*

*Recessed windows and doors*

*Photo courtesy of the Littleton Museum.*

## VERNACULAR RESIDENTIAL

(c. 1885-1910)

Sometimes referred to as “other,” “no style” or “folkhouses,” the vernacular residential style focuses on being functional. The houses are constructed of simple designs, some of which remained common for decades. Many of these designs were indeed based on popular styles of the time, but the vernacular structures were much simpler in form, detail and function. Elements from other styles found in the area will appear on the vernacular but in simple arrangements.

### Characteristics

- Hipped or gable roof over the main block
- One story porch, often extending the width of the building, hipped or shed forms
- Usually round columns
- Double-hung windows
- Clapboard wood siding, or shingles

### Sample Key Features:



*Many of the key features are still retained on this building; however, the porch railing and balusters are missing.*

# II. GENERAL PRINCIPLES OF HISTORIC PRESERVATION

While community goals and economic conditions change over time, preserving Littleton’s heritage remains a primary goal. This chapter establishes the principles for preservation, and provides steps to follow in planning an improvement project. These steps can be used by property owners to chart an appropriate approach for improving a historic property.



*The historic Carnegie Library is designed to be viewed “in the round,” with all facades conveying a high level of detail. (Historic photo at right courtesy of the Littleton Museum.)*

## IN THIS CHAPTER:

What Does Preservation Mean?	16
Historic Significance	16
Sustainability and Historic Buildings	19
Cultural/Social Component of Sustainability	20
Environmental Component of Sustainability	21
Economic Component of Sustainability	23
Preservation Principles	25
Planning a Preservation Project	27
Determining the Appropriate Treatment for a Property	31
Preferred Sequence of Actions for Individual Building Components	31
Flexibility and Facade Treatments	34





*Preservation includes maintaining the key, character-defining features which contribute to a building's significance, such as these details from the Old Town Hall building.*

*See the Littleton Zoning Ordinance for the criteria and procedures for designation to the Littleton Historical Register.*

## WHAT DOES PRESERVATION MEAN?

Preservation means keeping properties and places of historic and cultural value in active use. This includes accommodating appropriate improvements to sustain their viability while maintaining the key, character-defining features which contribute to their significance as historic resources. Preservation also means keeping historic resources for the benefit of future generations. That is, while maintaining properties in active use is the immediate objective, this is in part a means of assuring that these resources will be available for others to enjoy in the future. Historic preservation is also an integral component of initiatives in neighborhood livability, sustainability, economic development and culture.

## HISTORIC SIGNIFICANCE

### Age of Historic Resources

What makes a property historically significant? In Littleton, a property must be at least 40 years old before it can be evaluated for potential historic significance, although exceptions do exist when a more recent property clearly has historic value. This age threshold does not in itself mean that a property has historic significance. It must also meet defined criteria to determine significance.

### Criteria for Determining Significance

The following list of criteria for determining significance is based on the City of Littleton Historic Preservation Code. Please see the Code for a full list of criteria.

A property that has reached the age threshold must be significant for one or more of the following reasons:

- Association with events that have made a significant contribution to the broad patterns of the history, culture or heritage of Littleton, Colorado, or the United States,
- Association with the life or lives of one or more people important in the past,
- Embodies distinctive characteristics of a type, period, region, or method of construction, or that represent the work of an important creative individual, or possess high artistic values,
- A structure that yields or may be likely to yield, information important in history or prehistory,

- A structure, property, object, site, or area with sufficient integrity of location, design, materials and workmanship to make it worthy of preservation or restoration, or
- An established and familiar natural setting or visual feature of the community.

## The Period of Significance vs. a Period of Focus

In most cases, a property or district is significant because it represents or is associated with a particular period in its history. This is its Period of Significance. For Downtown Littleton the period of significance began in 1870 with the settlement of downtown, and currently extends through 1970. As time goes on and buildings continue to age, the period of significance may continue to expand. Typically the period of significance will end no closer than 40 years prior to the current date.

In contrast to this, a Period of Focus is a more limited time frame, typically lying within a more limited portion of the period of significance, representing the time during which the majority of development which reflects the character of the area took place. Downtown Littleton's period of focus is from 1870 to 1945. This covers the earliest days of settlement up to the end of World War II, and includes most of the buildings that define the historic character of downtown. The preservation of structures from the period of focus is a high priority. For buildings within this period that have been altered, restoration is usually the preferred treatment strategy. Buildings from the period of focus also establish the context for the design of new, compatible infill projects.

## Concept of Integrity

In addition to being historically significant, a property also must have integrity, with a sufficient percentage of the structure dating from its period of significance. Its character-defining features also should remain intact. These may include architectural details, storefronts, cornices, moldings and upper-story windows on commercial buildings and dormers, porches, ornamental brackets, and moldings on residential buildings. The overall building form and its materials should also remain primarily intact. These elements allow a building to be recognized as a product of its own time.



*The Old Town Hall serves as an accent to the traditional commercial storefront framework of the historic district. The building has a row of three gothic arches defining the street level, with a wall of recessed doors and windows.*

*See the Littleton Historic Preservation Code for the current definition of a Contributing Property.*

## Contributing and Non-Contributing Properties

Properties that are listed as being members of the downtown historic district are classified into two categories:

A “contributing” building or property is one that was present during the period of significance, possesses historic integrity or is capable of yielding important information about the period.

A “non-contributing” building is a building in the district that does not meet some or all the criteria for contributing properties (including period of significance), is in a state of significant decay, or has been significantly altered. New construction that has not reached the age threshold may also be within this category.

### BUILDING INTEGRITY

#### Contributing Property



*This building retains its integrity.*

#### Contributing Property with Some Alterations



*This building retains its integrity.*

#### Non-Contributing Property with Major Alterations



*This building does not retain its integrity.*

## **SUSTAINABILITY AND HISTORIC BUILDINGS**

The benefits of preserving historic resources and in conserving older buildings and neighborhoods in Littleton can be described in the three basic categories of sustainability which are: (1) Cultural/Social, (2) Environment and (3) Economics.



*Preserving historic places promotes the three basic categories of sustainability.*



*When historic buildings occur on a block, they create a street scene that is “pedestrian friendly,” and encourages walking and neighborly interaction.*

## **CULTURAL/SOCIAL COMPONENT OF SUSTAINABILITY**

Historic landscapes, sites, structures, buildings and features are essential components of the city’s identity. Preserving historic places, including landmarks and neighborhoods, helps maintain a connection to the community’s heritage. This has been a fundamental part of the preservation movement in Littleton since its beginning.

When historic buildings occur on a block, they create a street scene that is “pedestrian friendly,” which encourages walking and neighborly interaction. Decorative architectural features also contribute to a sense of identity. This sense of place reinforces desirable community social patterns and contributes to a sense of security, which enhances the quality of life for all. Historic properties also provide direct links to the past. They convey information about earlier ways of life that helps current residents anchor their sense of identity with the community, which is a key ingredient in cultural sustainability.

Preserving existing neighborhoods also helps retain the social fabric of the city. Older neighborhoods are relatively compact, and lend themselves to walking. Residences are within convenient access to public transportation systems in many of these places, thereby reducing vehicle miles traveled by car. Walkability also supports healthy living initiatives that enhance the quality of life for the city’s residents. While this could be considered a part of the environmental component of sustainability, it crosses over into social considerations, in that these places help support a sense of community.





## ENVIRONMENTAL COMPONENT OF SUSTAINABILITY

The environmental component of sustainability tends to be the main focus when discussing historic structures and their relationship to green building. Among other things, this component focuses on saving energy, and generating it through “clean” methods, as well as minimizing demand for water and conserving building materials.

Sustainable development and conservation of resources are central principles of preservation. Sensitive stewardship of the existing building stock significantly reduces environmental impacts. Re-using a building preserves the energy and resources invested in its construction, and reduces the need for producing new construction materials, which will require more energy to produce. In contrast, manufacturing of many new building materials uses substantial levels of energy. This further contributes to the carbon footprint of the demolish-and-replace cycle. Increased burden on municipal land fill is another related impact. According to the EPA, building debris constitutes around a third of all waste generated in the country. This can be reduced significantly if historic structures are retained rather than demolished.

### Embodied Energy

Embodied energy is defined as the amount of energy expended to create the original building and its components. Preserving a historic structure retains this energy. If demolished, this investment in embodied energy is lost and significant new energy demands are required to replace it. Studies confirm that the loss of embodied energy associated with replacing an existing structure takes three decades or more to recoup from reduced operating energy costs in a high-efficiency replacement building.



*Re-using a building preserves the energy and resources invested in its construction, and reduces the need for producing new construction materials, which will require more energy to produce. The reuse of historic buildings in Downtown Littleton contributes to the environmental sustainability of the community.*



*The Coors building, located within the Opt-in Main Street Historic District, has double-hung windows and awnings; both are example of historic building features used for energy efficiency.*

## Building Materials

Many historic building materials have long life cycles, which contribute to their sustainability. Buildings constructed with wood, stone, and brick were built for longevity, in a manner that also allows for repairs. Some new materials are less sustainable and require extraction of raw, non-renewable materials.

The sustainable nature of historic construction is best illustrated by a window. Older windows were built with well seasoned wood from stronger, durable, weather resistant old growth forests. A historic window can be repaired by reglazing and patching and splicing the wood elements. Many newer windows cannot be repaired and must be replaced entirely. If a seal is disturbed in a vinyl window the best approach is to replace that particular window, rather than repair the part, as is the case for a historic wood window.

## Building Energy Savings

An older window is often falsely accused of being a major source of heat loss. Repairing, weather-stripping and insulating an original window is typically more energy efficient and much less expensive than new windows, as well as sound preservation practice.

Other parts of a building are more likely to be sources of major heat loss. For example, as much as 50% of the energy lost from a house is from air infiltration through the attic, uninsulated walls, and around the windows and door cavities, and not through the glass in a window itself. Repairing an existing window and also adding insulation in the attic will effectively save energy at a higher rate than through the replacement of single paned wood windows with double or triple paned alternatives.

Adding 3.5 inches of insulation in the attic has three times the R value benefit compared with moving from the least energy efficient single pane window with no storm window to the most efficient new window. Other techniques to improve energy efficiency without replacing historic building elements include adding weather stripping to windows and doors, interior storm windows, and the installation of insulated window shades.

## Construction Quality

As a rule, the quality of early construction and materials was higher than those used in many late 20th Century buildings. Lumber used in early Littleton came from mature trees, was properly seasoned and typically milled to “full dimensions,” providing stronger framing and construction. Buildings also were thoughtfully detailed and the finishes were generally of high quality—characteristics that owners today appreciate. The high quality of construction in earlier buildings is therefore an asset that is impossible to replace.

## Adaptability

Owners also recognize that floor plans of many historic properties easily accommodate changing needs. They permit a variety of uses while retaining the overall historic character.



*The high quality of construction typically found in earlier buildings, such as those in Downtown Littleton, is an asset that is impossible to replace.*



## ECONOMIC COMPONENT OF SUSTAINABILITY

Historic buildings represent substantial investment by previous generations. Using these existing assets yields economic benefit and adds value. Other economic benefits occur with actual rehabilitation projects and the income brought in from heritage tourism.

The economic benefits of protecting local historic districts are well documented across the nation. These include higher property values, increased heritage tourism and job creation in rehabilitation industries which often include more local jobs than new construction industries. Examples also exist of ways in which the quality of life is enhanced by living in historic areas, and that these in turn help to recruit desirable businesses to the community at large.



*Historic rehabilitation projects provide functional, distinctive, and affordable space for local small businesses and supports the economic sustainability of the local economy.*

*See the Community Development Department for information on grant programs, tax credits, and other programs and incentives for historic preservation projects.*

## **Historic Rehabilitation Projects**

Direct and indirect economic benefits accrue from a rehabilitation project. Direct benefits result from the actual purchases of labor and materials, while material manufacture and transport results in indirect benefits. Preservation projects are generally more labor intensive, with up to 70% of the total project budget being spent on labor, as opposed to 50% when compared to new construction. All of these purchases of labor and materials add dollars to the local economy. Furthermore, a rehabilitation project will provide functional, distinctive, and affordable space for new and existing small businesses. This is especially relevant to the local economy where many local businesses operate in historic buildings.

## **Heritage Tourism**

Heritage tourism is another benefit of investment in historic preservation, as people are attracted to the cultural heritage sites within an area. Historic resources provide visitors with a glimpse into Littleton’s heritage and its contribution to state and national history. The National Trust for Historic Preservation defines cultural heritage tourism as, “traveling to experience the places, artifacts, and activities that authentically represent the stories and people of the past and present. It includes cultural, historic, and natural resources.” Heritage tourists spend more on travel than other tourists, which generates jobs in hotels, bed and breakfasts, motels, retail stores, restaurants, and other service businesses.

## **PRESERVATION PRINCIPLES**

With an understanding of the basic concepts of historic significance and integrity, it is now important to review the key principles which underlie the more specific design guidelines that appear later in this document. The following preservation principles apply to all historic properties:

*The HPB will consider these Preservation Principles when reviewing work proposed on a historic resource.*

### **P1. Respect the historic character of a property.**

- Don't try to change the style of a historic resource or make it look older than its actual age. Confusing the character by mixing elements of different styles or periods can adversely affect the appearance and historic quality of the property.

### **P2. Maintain significant features and stylistic elements.**

- Distinctive stylistic features and other examples of skilled craftsmanship should be treated with sensitivity. The best preservation procedure is to maintain historic features from the outset to prevent the need for repair later. Protection includes maintaining historic material through appropriate maintenance such as rust removal, caulking, limited paint removal and reapplication of paint.

### **P3. Preserve original building materials and design features.**

- Avoid removing or altering original materials and their finishes.
- Also preserve original doors, windows, porches and other architectural features.

### **P4. Repair deteriorated historic features and replace only those elements that cannot be repaired.**

- Upgrade existing material, using recognized preservation methods whenever possible. If disassembly is necessary for repair or restoration, use methods that minimize damage to original materials.



*The adaptive reuse of this residential structure to commercial uses maintained the historic character of the property while accommodating the new function to keep it in active use.*

## **P5. Seek uses that are compatible with the historic character of the property.**

- Converting a building to a new use different from the original use is considered to be an “adaptive reuse,” and is often a sound strategy for keeping an old building in service. For example, converting a residential structure to offices is an adaptive use. A good adaptive use project retains the historic character of the building while accommodating a new function. Building uses that are closely related to the original use are preferred. Every reasonable effort should be made to provide a compatible use for the building that will require minimal alteration to the building and its site.
- Changes in use requiring the least alteration to significant elements are preferred. In some instances, however, a radical change in use may be necessary to keep the property in active service. In order to adapt a building to a new, and substantially different use, the alterations required may be too extreme and the loss of historic building fabric would result in a loss of integrity. In most cases designs can be developed that respect the historic integrity of the building while also accommodating new functions.

## PLANNING A PRESERVATION PROJECT

When planning a preservation project, it is important to determine the significance of the property and the degree to which it retains its integrity as a historic resource. Then, a specific approach to the overall treatment of the property should be established. This may include keeping the building in its current character, while making appropriate repairs, or also incorporating new, compatible changes. It is then important to determine how surviving historic features will be treated. This may include preserving those features that remain intact, repairing those that are deteriorated and replacing others. These steps in planning a preservation project are presented in this section, and illustrated in the following table.



*When planning a preservation project, it is important to determine the significance of the property and the degree to which it retains its integrity as a historic resource. Use the steps on the following pages to help plan a preservation project.*

### Step 1: Determine Significance.

Understanding the history of a building is important to any preservation project. Identifying the building's key features and its period of significance are important first steps. This will help determine to what degree the property should be preserved as it is, or where there may be opportunities for compatible alterations to occur.

### Step 2: Determine Integrity.

The condition of the building and its features contribute to the overall significance of the building. Key character-defining features and characteristics from its period of significance should remain intact. These key elements allow a building to be recognized as a product of its time.

### Step 3: What are the Program Requirements?

If restoring features is the focus, then other alternatives may not be necessary, but if some functional improvements are also needed, then developing a plan for compatible alterations and/or additions may be indicated.

## STEPS FOR PLANNING A PRESERVATION PROJECT



**Why is the Building Significant?**

**1. Determine Significance**

Understanding the history of a building and identifying its key features will help determine to what degree the property should be preserved as it is, or where there may be opportunities for compatible alterations to occur.



**What Condition is the Building and its Key Features in?**

**2. Determine Integrity**

A building with historic integrity has a sufficient percentage of key character-defining features and characteristics from its period of significance which remain intact.

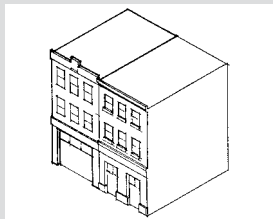

**What is the Desired Project?**

**3. Consider Desired Program**

Are functional improvements needed? Or is a simple restoration of key features the objective?

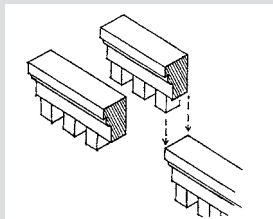

**Determine the Treatment Strategy**

**4. Treatment Strategy**

With the assessment of significance, building conditions and program requirements, now select the appropriate approach. See page 29 for definitions of these alternative treatments.

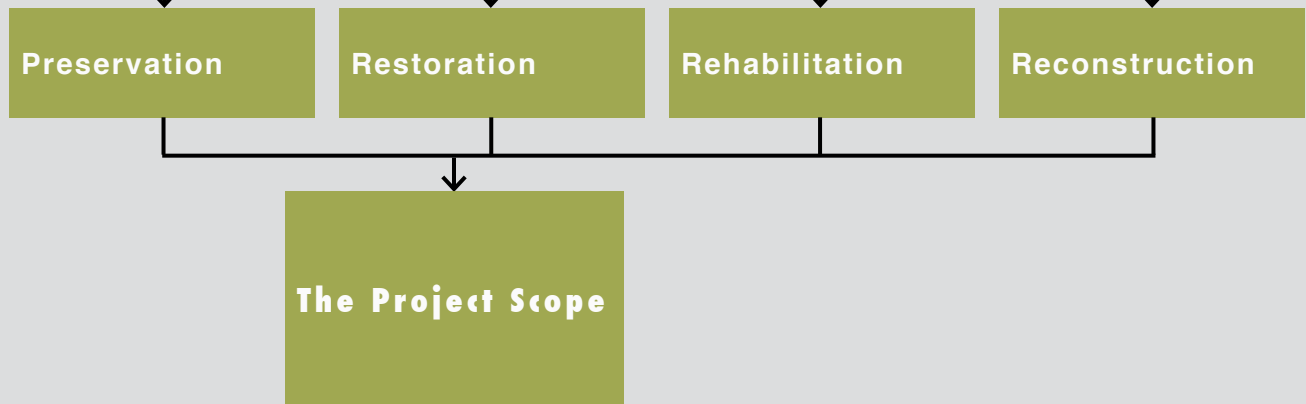



## Step 4: Choose an Approach for Improvement.

A preservation project may include a range of activities, such as maintenance of existing historic elements, repair of deteriorated materials, the replacement of missing features and construction of a new addition. While the term “preservation” is used broadly to mean keeping a historic property’s significant features, it is also used in a more specific, technical form to mean keeping a resource in good condition. This, and other related terms, are important to understand because they are all used when planning the scope of a project for improvements to a historic resource.

### Accepted Treatments:

These approaches are appropriate for contributing properties:

#### Preservation

“Preservation” is the act or process of applying measures necessary to sustain the existing form, integrity, and materials of an historic property. Some preservation work focuses on keeping a property in good working condition by repairing features as soon as deterioration becomes apparent, using procedures that retain the original character and finish of the features. Property owners are strongly encouraged to maintain properties in good condition.

#### Rehabilitation

“Rehabilitation” is the process of returning a property to a state that makes a contemporary use possible while still preserving those portions or features of the property which are significant to its historical, architectural and cultural values. Rehabilitation may include a change in use of the building or additions. This term is the broadest of the appropriate treatments and is often used in the guidelines with the understanding that it may also involve other appropriate treatments.

#### Restoration

The act or process of accurately depicting the form, features, and character of a property as it appeared at a particular period of time by means of the removal of features from other periods in its history and reconstruction of missing features from the restoration period.



*“Preservation” is the act or process of applying measures necessary to sustain the existing form, integrity, and materials of an historic property. Property owners are strongly encouraged to maintain properties in good condition.*

### **Reconstruction**

The act or process of depicting, by means of new construction, the form, features and detailing of a non-surviving site, landscape, building, structure or object for the purpose of replicating its appearance at a specific time and in its historic location.

### **Combining Treatments**

While these terms are used interchangeably in informal conversation, the more precise meanings are useful in describing the overall strategy for a contributing property.

For many improvement projects in Downtown Littleton, a rehabilitation approach will be the overall strategy. Within that, however, there may be a combination of these approach options as they relate to specific building components. For example, a surviving cornice may be preserved, a storefront base that has been altered may be restored, and a missing kickplate may be reconstructed. This analysis of individual components is described in the next step.

### **Inappropriate Treatments**

The following approaches are not appropriate for historically significant properties:

#### **Remodeling**

The process of changing the historic design of a building. The appearance is altered by removing original details and by adding new features that are out of character with the original. Remodeling of a historic structure is inappropriate.

## DETERMINING THE APPROPRIATE TREATMENT FOR A PROPERTY

### PREFERRED SEQUENCE OF ACTIONS FOR INDIVIDUAL BUILDING COMPONENTS

Selecting an appropriate treatment for specific building components of contributing properties will provide for proper preservation of key, character-defining features. The preservation method that requires the least intervention is preferred. By following this tenet, the highest degree of integrity will be maintained for the property. The following treatment options are presented in order of preference. When making a selection, follow this sequence:

#### First: Preserve

If a feature is intact and in good condition, maintain it as such.

#### Second: Repair

If the feature is deteriorated or damaged, repair it to its original condition.

#### Third: Replace

If it is not feasible to repair the feature, then replace it with one that is the same or similar in character (e.g., materials, detail, finish) to the original one. Replace only that portion which is beyond repair.

#### Fourth: Reconstruct

If the feature is missing entirely, reconstruct it from appropriate evidence.

#### Fifth: Compatible Alteration

If a new feature or addition is necessary, design it in such a way as to minimize the impact on original features. It is also important to distinguish new features from original historic elements.

### PREFERRED SEQUENCE FOR THE TREATMENT OF A KEY FEATURE

First:

**Preserve**



Second:

**Repair**



Third:

**Replace**



Fourth:

**Reconstruct**



Fifth:

**Make Compatible Alterations**

*See the Community Development Department for assistance determining appropriate treatment strategies for your project.*

## Replacing or Reconstructing Historic Features

### Choosing

#### Treatment 3:

**Reconstruct**

**OR**

#### Treatment 4:

**Replace**

When a historic building component must be replaced, how accurate should the replacement be? There are three approaches:

#### **Approach A: Reconstruct the historic design.**

In this approach, the replacement is constructed with materials, finishes and details that are similar to that which existed historically.

#### **Approach B: Replace with simplified interpretation.**

In this approach, the replacement is a simplified interpretation of the original feature, matching the original in style, materials, and some finishes and details.

#### **Approach C: Replace with a contemporary but compatible new feature.**

Replacing the missing feature with a contemporary but compatible one is also an option. This approach uses a modern interpretation of the building element. Historic details would not be copied literally yet the design would reflect the general form and character of the original. See page 37 for an example of a contemporary but compatible storefront project.

### Choosing a Treatment Option

When a historic building component (deteriorated, missing or non-historic) must be reconstructed or replaced there are three questions to consider to determine which treatment strategy, A, B or C is appropriate:

#### **First: What is the significance of the building?**

If the building has a high level of significance, then approach A is preferred. If reconstruction is not feasible than approach B should be used. If the building is contributing to the historic sense of the street but is not landmark quality, then more flexibility may be allowed. Replacing the feature using approaches A, B or C can be considered.

#### **Second: To what degree has the building retained its historic integrity and how important is the feature in conveying the historic character of the building?**

If the building retains a high degree of integrity and the missing feature is important to the building's character, then it should be reconstructed. If reconstruction is not feasible than approach B should be used. If the building has been substantially altered, then all approaches may be considered.

#### **Third: What is the quality of information about the historic feature of the building?**

Generally, there are three types of information that might be available about the historic feature: pictures or architectural plans of the actual features, existing remnants of the historic features (including marks on the building showing the outline of the feature), or examples of comparable features on existing buildings that were built at the same time and of the same general design. If pictures, plans or remnants exist, then Option A is preferred. If sufficient information is not available about the historic feature to be confident that it can be replaced accurately, approach B or C may be considered.



*This contemporary but compatible storefront is an example of Approach C for replacing or reconstructing a historic feature.*

## COMMERCIAL FACADES **FLEXIBILITY AND FACADE TREATMENTS**

### Primary Facade

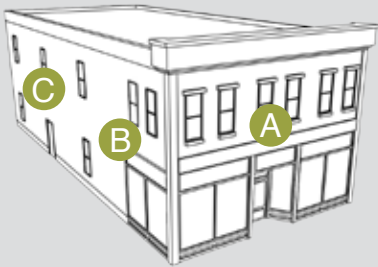

### Rear Wall

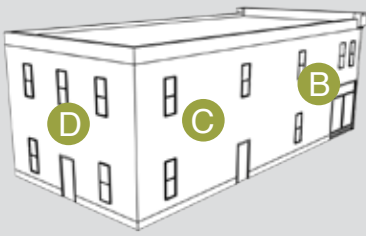

Retaining as much of a building’s original fabric as possible is a key principle for historic properties; however, there are times when some degree of flexibility in making alterations may be considered, especially when it will help sustain the property. Such decisions are based on the significance of the property, its location, and how the alteration will affect the integrity of the structure. How the change will affect the overall character of the district should also be considered.

For most historic resources in Littleton, the front wall is the most important to preserve intact. Alterations are rarely appropriate. Many side walls are also important to preserve where they are highly visible from the street. By contrast, portions of a side wall that are not as visible may be less sensitive to change. The rear wall is usually the least important, and alterations can occur more easily without causing negative effects to the historic significance of the property. This concept of evaluating the different faces of a building to locate appropriate alterations is illustrated in sketches at the left.

## RESIDENTIAL FACADES

### Primary Facade



### Rear Wall

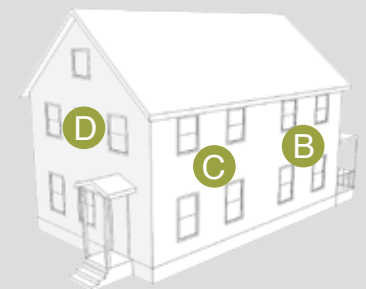

#### Location A: Primary Facade

- Preservation and repair of features in place is the priority.
- This is especially important at the street level and in locations where the feature is highly visible.

#### Location B: Highly visible Secondary Wall

- Preservation and repair in place is the priority.

#### Location C: Not highly visible Secondary Wall

- Preservation is still preferred.
- A compatible replacement or alteration is acceptable.
- More flexibility in treatment may be considered.

#### Location D: Not highly visible Rear Wall

- A compatible replacement or alteration may be acceptable when it is not visible to the public.
- More flexibility in treatment may be considered.

# III. DESIGN GUIDELINES FOR HISTORIC PROPERTIES

This chapter provides the essential guidance for rehabilitation of historic properties in the downtown. The guidelines apply to those properties in the Main Street Historic District that are designated as “contributors,” as well as buildings outside the district that are individually landmarked. Owners of properties on the List of Merit are also encouraged to use these guidelines. They will be used in conjunction with the principles presented Chapter II when evaluating the appropriateness of a proposed project.

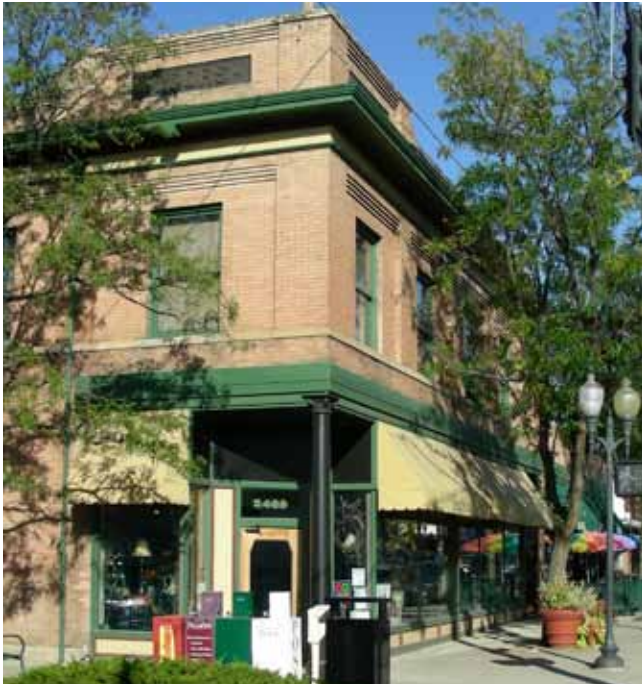

## IN THIS CHAPTER:

<b>Solutions for the Treatment of Individual Building Components</b>	<b>36</b>
Commercial Facades and Storefronts	36
Windows	40
Doors	43
Roofs	44
Building Materials	46
Cornices, Moldings and Other Architectural Details	50
<b>Solutions for Additions to Historic Buildings</b>	<b>53</b>
Automated Teller Machines (ATMs)	54
Options for Additions to Commercial Properties	56
Options for Additions to Residential Properties	57
<b>Solutions for Historic Site Features</b>	<b>58</b>
<b>Solutions for Sustainability</b>	<b>59</b>
Planning a Rehabilitation Project for Energy Efficiency	59
Maintaining the Inherent Energy Efficiency of a Historic Building	62
Options for Enhancing Energy Performance in Historic Structures	63
Solutions for Energy Generating Technologies	65

## SOLUTIONS FOR THE TREATMENT OF INDIVIDUAL BUILDING COMPONENTS

### COMMERCIAL FACADES AND STOREFRONTS

Many storefronts in Downtown Littleton have components seen traditionally on commercial buildings. The repetition of these standard elements creates a visual unity at the street that should be preserved. This also helps maintain interest for pedestrians by providing views to goods and activities inside. Retaining these features will also support the City’s sustainability objectives (see page 19).



*Preserving a historic facade or storefront helps maintain interest for pedestrians by providing views to goods and activities inside.*

*For guidelines on signs see the Downtown Design Standards and Guidelines and the Sign Code of the City of Littleton.*

#### 3.1 Preserve the character-defining elements of a traditional storefront.

- See the styles section in Chapter I to identify key features.

#### 3.2 Repair an altered storefront to its original design.

- Use historic photographs to determine the original character.
- If evidence of the original design is missing, a simplified interpretation of similar storefronts may be used. (See the following diagram.)

#### 3.3 A contemporary interpretation of a traditional storefront may be considered.

- Where the original storefront is missing and no evidence of its character exists, a new design that uses the traditional elements may be appropriate.
- The new design should convey the basic character of typical storefronts in the area.
- The storefront system should be in proportion to the building, with storefront components appropriately proportioned to one another. (See storefront diagram on page 5).



## OPTIONS FOR AN ALTERED HISTORIC COMMERCIAL FACADE

The guidelines in this section discuss a range of treatment options for commercial facades. When applied to a building that is already altered, which would be the best approach? This diagram outlines the steps to follow and the factors to consider in making that decision. The City will work with the property owner to determine the best approach.



### Option 1: Reconstruct



#### When should I use this approach?

- The building is highly significant
- There is good historical information about the design
- The needed materials and craftsmen are available
- The project budget permits
- The context has many intact historic buildings

### Option 2: Simplified Interpretation



#### When should I use this approach?

- The building is a contributor to a district
- There is less historical information available about the original design
- The budget is more limited
- The work will be phased

### Option 3: Contemporary Interpretation



#### When should I use this approach?

- There is substantial deterioration, making “Option 1” difficult.
- There is less historic information about the original design
- The context has more variety

## TREATMENT OF AN ALTERED HISTORIC CORNICE

### Existing Building



*Existing building with missing cornice.*

### Reconstructed Cornice



*Reconstruct a missing cornice when historic evidence is available.*

### Simplified Cornice



*A simplified interpretation is appropriate if evidence of the original is missing.*

## Treatment Strategies for Storefronts

### Kickplates

#### 3.4 Retain the kickplate as a decorative panel.

- If the original kickplate is covered with another material, consider exposing the original design.

#### 3.5 If the original kickplate is missing, develop a sympathetic replacement design.

- Wood is an appropriate material for a replacement on most styles. Alternative materials may also be considered when appropriately used with the building style.

### Cornices

#### 3.6 Preserve the character of the cornice.

- Many cornices are made of sheet metal, which is easy to repair.

#### 3.7 Reconstruct a missing cornice when historic evidence is available.

- Use historic photographs to determine design details.
- It should match the original, especially in overall size and profile.

#### 3.8 A simplified interpretation of a cornice may be considered if evidence of the original is missing.

- Appropriate materials include stamped metal, wood and some durable synthetics.

### Parapets

#### 3.9 A parapet wall should not be altered.

- This is especially important on primary elevations or in highly visible locations.
- Inspect parapets on a regular basis. Watch for deterioration such as missing mortar or excessive moisture.
- Avoid waterproofing treatments, which can interfere with the parapet's natural ability to dry out quickly.

## Transoms

### 3.10 Maintain an original transom window.

- Avoid removing or enclosing a transom.
- A transom introduces light into the depths of the building, saving on lighting costs.
- Maintain the operability of a transom window, which provides natural ventilation and interior climate control. See page 62 for a diagram of a transom window.
- The shape of the transom is important to the proportion of the storefront, and should be preserved in its historic configuration.

## Awnings

Traditionally, awnings were noteworthy features of commercial building types, and their continued use is encouraged. Operable awnings also help regulate internal climatic conditions. They are typically simple in detail.

### 3.11 Use an operable awning where appropriate.

- An operable awning can increase the energy efficiency of a building, providing shading in the summer and solar access in the winter.

### 3.12 Design an awning to be in character with the building.

- Mount an awning to accentuate character-defining features.
- Use colors that are compatible with the facade. Solid colors are encouraged.
- Simple shed shapes are appropriate for rectangular openings. Odd shapes, bullnose and bubble awnings are inappropriate.
- Historically, fabric awnings were the most common type found in the downtown area and are encouraged. However, a fixed metal canopy may also be considered where compatible with the style of the building.
- Internal illumination of an awning is inappropriate.

### 3.13 Design an awning to be in proportion to the building.

- The awning should fit in the opening it covers.
- Avoid covering or obscuring significant features.

## USING OPERABLE AWNINGS FOR ENERGY EFFICIENCY

### Awnings Open to Provide Shading

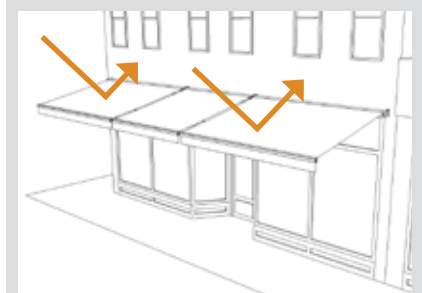

*Awnings can be opened in the summer to provide shading for a storefront and the sidewalk.*

### Awnings Closed to Allow Solar Access

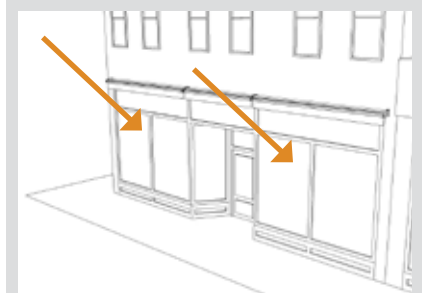

*Awnings can be closed in the winter to provide solar heat gain and daylighting.*



*Use an operable awning where appropriate. In this example awnings are used to shade the storefront and prevent solar heat gain in the summer.*



*The character-defining features of a historic window, its distinct materials and its placement should be preserved.*



*Consider use of a storm window to enhance the energy efficiency of an existing historic window.*

## WINDOWS

### Treatment of Historic Windows

The character-defining features of a historic window, its distinct materials and its placement should be preserved.

#### 3.14 Preserve the functional and decorative features of a historic window.

- Repair frames and sashes rather than replacing them, whenever possible.
- See the diagrams on page 41.

#### 3.15 Preserve the position, number and arrangement of historic windows in a building wall.

- On primary facades, enclosing a historic window opening is inappropriate, as is adding a new window opening.
- Greater flexibility in installing new windows may be considered on secondary and rear walls. (See page 34 for more information on flexibility.)

#### 3.16 Preserve the historic ratio of window openings to solid wall on a primary facade.

- Significantly increasing the amount of glass on a character-defining facade will negatively affect the integrity of the structure.

#### 3.17 Preserve the size and proportion of a historic window opening on a primary facade.

- Reducing an original opening to accommodate a smaller window or increasing it to receive a larger window is inappropriate.

### Energy Conservation in Windows

Historic windows can be repaired more easily than often thought. They were built with well seasoned wood and other durable materials. Repair and adding weatherstripping usually will be more energy efficient and much less expensive. Substantial amounts of information are available that document the energy saving benefits of retaining and repairing a historic window, rather than replacing it.

#### 3.18 Enhance the energy efficiency of an existing historic window, rather than replace it. Use these measures:

- Add weather stripping around the window frame.
- Install a storm window.
- Install an insulated window shade.
- Also see the sustainability guidelines on page 59.

## TYPICAL HISTORIC WINDOW COMPONENTS

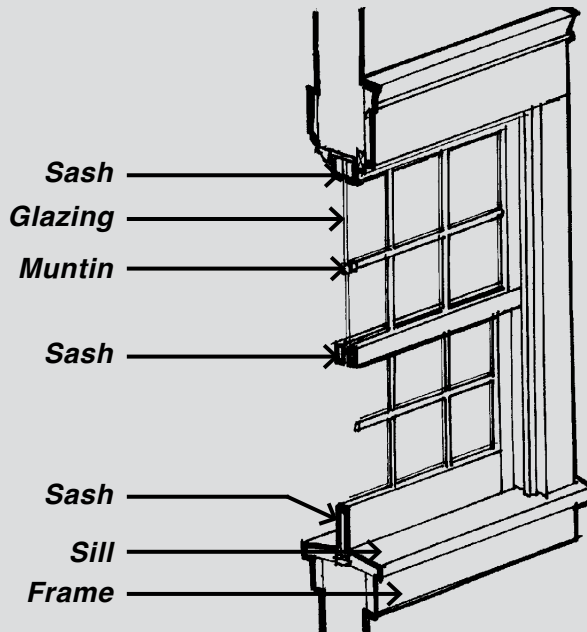

*Double Hung Window (Residential, Commercial, Industrial, Agricultural)*

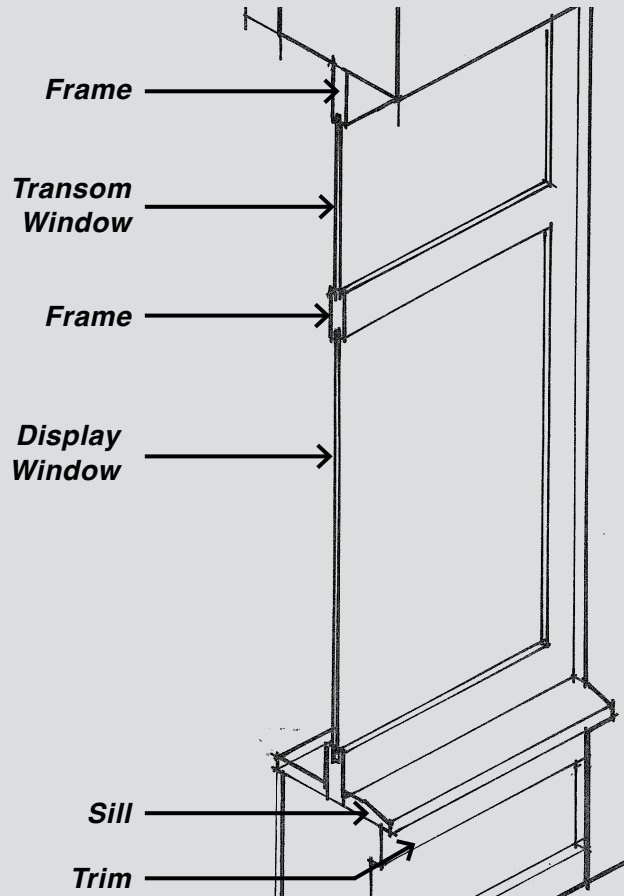

*Storefront Window (Commercial)*

## **Options for Replacing a Window**

A replacement should match the original as closely as possible. When considering replacing or altering a window, evaluate its condition, significance and location. In some cases such work on a secondary wall may be more acceptable. See page 34 for more information on flexibility in facade treatments.

### **3.19 Match a replacement window to the original in its design.**

- If the original is double-hung, then the replacement window also should be double-hung, or appear to be so. Also match the number and position of glass panes.
- Matching the original design is particularly important on key character-defining facades.

### **3.20 Use materials in a replacement window that appear similar to the original.**

- Using the same material as the original is preferred, especially on character-defining facades. However, a substitute material may be considered if the appearance will match the original in dimension, profile and finish.
- An alternative material should have demonstrated durability in the local climate.
- The glass should be clear. Metallic and reflective finishes are inappropriate. In some instances colored or tinted glass may be appropriate in commercial storefront transoms or residential windows.

### **3.21 Match, as closely as possible, the profile of the sash and its components to that of the original window.**

- A historic window has a distinct profile, which should be reflected in a replacement. (See diagram on page 41).

### **3.22 Convey as closely as possible the character of historic sash divisions in a new window.**

- Muntins that divide a window into smaller panes of glass should be genuine on key facades and other highly visible places.
- Snap-in muntins located on the outside of a window may be used in secondary locations, but should have a similar depth and shadow line.
- Strips of material located between panes of glass to simulate muntins are inappropriate.

## DOORS

### Treatment of Historic Doors

The character-defining features of a historic door, its distinct materials and placement should be preserved.

#### 3.23 Preserve the decorative and functional features of a primary entrance.

- These include the door, door frame, screen door, threshold, glass panes, paneling, hardware, detailing, transoms and flanking sidelights.
- Avoid changing the position of an original front door on a key facade.

#### 3.24 Maintain the original proportions of a significant door.

- Altering the original size and shape of a significant door is inappropriate.

#### 3.25 Repair a damaged historic door.

- Maintain its general historic appearance where repairing it.

### Options for Replacement Doors

When a new door is needed, it should be in character with the building.

#### 3.26 When replacing a door, use a design that has an appearance similar to the original.

- The replacement door should match the original as closely as possible.
- Use materials that appear similar to the original.
- Where the original design is unknown, use a door design associated with the building style or type.

### TYPICAL HISTORIC DOOR TYPES



*Door with transom and sidelights*



*Paneled Door with glass panes*



*Paneled Door*

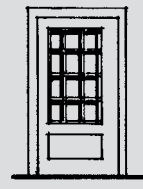

*Period Revival Door*

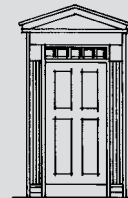

*Colonial Revival Door*



*Half Glass Door*



*The character-defining features of a historic door, its distinct materials and placement should be preserved.*

**TYPICAL  
COMMERCIAL ROOF  
TYPES**

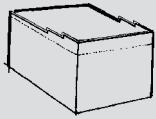

*Commercial  
Flat roof*

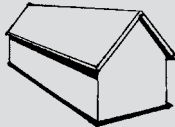

*Gabled roof*

**TYPICAL  
RESIDENTIAL ROOF  
TYPES**

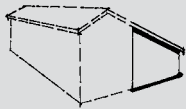

*Shed roof*

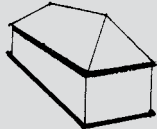

*Hipped roof*

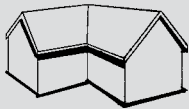

*Cross-Gabled  
roof*

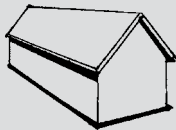

*Gabled roof*

**Roofs**

**Treatment of a Historic Roof**

The character of a historic residential roof, its form and materials, should be preserved.

**3.27 Preserve the original roof form of a historic structure.**

- Avoid altering the angle of a historic roof. Instead, maintain the perceived line and orientation of the roof as seen from the street.
- Retain roof detailing, including gutters and downspouts.

**3.28 Preserve the original eave depth of a roof.**

- The shadows created by traditional overhangs contribute to one’s perception of the building’s historic scale and therefore these overhangs should be preserved. Cutting back roof rafters and soffits, or in any way altering the traditional roof overhang, is inappropriate.

**3.29 Preserve original roof materials.**

- Avoid removing historic roofing material that is in good condition.
- Also preserve decorative elements, including finials, crests and chimneys.



*Preserve the original eave depth of a roof (left). Cutting back roof rafters and soffits (right), or in any way altering the traditional roof overhang, is inappropriate.*



## Options for Roof Repair

When repairing a roof on a residential building type, its historic character should be maintained.

### 3.30 Use new roof materials which convey a scale and texture similar to those used traditionally.

- When replacement is necessary, use materials similar to the original in both style as well as physical qualities such as texture and color.
- When choosing a roof replacement material, the architectural style of the structure should be considered. (See the styles section in Chapter I.)
- Specialty materials such as tile or slate should be replaced with a matching material.
- Composition shingle roofs are generally appropriate replacements for wood shingles. They should have a color similar to the original, or of the material in weathered condition.
- Shingles that contain embedded photovoltaic systems are also appropriate in dark colors, or a color similar to that of the historic roof.

### 3.31 If metal roof materials are to be used, they should be applied and detailed in a manner compatible with the historic character and not distract from the historic appearance of the building.

- Metal roof materials should have a matte, non-reflective finish.
- Seams should be of a low profile.
- The edges of the roofing material should be finished similar to those seen historically.



*Maintain the historic character of a roof on a residential building type.*



*Consider removing later covering materials that have not achieved historic significance. Once the non-historic siding is removed, repair the original, underlying material.*

## BUILDING MATERIALS

Historic building materials found in Downtown Littleton include wood, stone, brick, stucco, plaster and concrete. Primary historic building materials should be preserved in place whenever feasible. When the material is damaged, then limited replacement matching the original, should be considered. Primary historic building materials should never be covered or subjected to harsh cleaning treatments.

### **3.32 Preserve original building materials.**

- Avoid removing original materials that are in good condition or that can be repaired in place.
- Preserving original building materials reduces the environmental impacts from producing new replacement materials.

### **3.33 Repair deteriorated primary building materials by patching, piecing-in, consolidating or otherwise reinforcing the material.**

- Isolated areas of damage may be stabilized or fixed, using consolidants. Epoxies and resins may also be considered for wood repair and special masonry repair components.

### **3.34 Match the original material in composition, scale and finish when replacing materials on primary surfaces.**

- Remove only those materials which are deteriorated, and must be replaced.
- Replace only the amount required.

### **3.35 Consider removing later covering materials that have not achieved historic significance.**

- Once the non-historic siding is removed, repair the original, underlying material.
- If a structure has a stucco finish, removing the covering may be difficult, and may not be desirable.

### 3.36 Covering original building materials with new materials is inappropriate.

- Vinyl siding, aluminum siding and new stucco are generally inappropriate on historic buildings. Other imitation materials that are designed to look like wood or masonry siding, fabricated from other materials, are also inappropriate.
- If a property already has a non-historic building material covering the original, it is not appropriate to add another layer of new material, which would further obscure the original.

## Wood

Wood is a material used historically for exterior siding, trim and ornamental details. Early woodwork should be retained, and, if necessary repaired. Traditional wood framing and cladding will usually be carefully chosen, seasoned and tough. Contemporary replacement wood is unlikely to have the same resilience. When properly maintained, wood has a long lifespan. To preserve external wood, maintain its painted finish.

### 3.37 Protect wood features from deterioration.

- Maintain protective coatings to retard drying and ultra-violet damage. If wood siding was painted originally, it should remain painted.
- Provide proper drainage and ventilation to minimize rot.



*Wood is a material used historically for exterior siding, trim and ornamental details. Early woodwork should be retained, and, if necessary repaired.*



*Masonry features that define the overall historic character, such as walls, cornices, pediments, steps and foundations, should be preserved.*



*Repoint mortar joints where there is evidence of deterioration.*

## Masonry and Concrete

Masonry includes a range of solid construction materials, including stone, brick, terra cotta, stucco and concrete.

### 3.38 Preserve masonry features that define the overall historic character of a building.

- Examples are walls, cornices, pediments, steps, chimneys and foundations.
- Masonry features that define the overall historic character, such as walls, cornices, pediments, steps and foundations, should be preserved.
- Avoid rebuilding a major portion of exterior masonry walls that could be repaired.

### 3.39 Brick or stone that was not painted historically should not be painted.

- Masonry naturally has a water-protective layer, or patina, to protect it from the elements. Painting masonry walls can seal in moisture already in the masonry, thereby not allowing it to breathe and causing extensive damage over the years.

### 3.40 Repoint mortar joints where there is evidence of deterioration.

- Duplicate the old mortar in strength, composition, color and texture.
- Avoid using mortar with a high Portland cement content, which will be substantially harder than the original.
- Duplicate the mortar joints in width and profile.

### 3.41 Protect concrete structures from water deterioration.

- Provide proper drainage so that water does not stand on flat, horizontal surfaces or accumulate in decorative features.
- Provide positive drainage away from concrete foundations to minimize rising moisture.

## Solutions for New Materials on Historic Buildings

In some rare cases, a substantial portion of the material on an existing wall may need to be replaced, because the original is beyond repair. If this is on a primary elevation that is key to the significance of the structure, the replacement should match the original in character, including size, texture and finish. Ideally, it will be of the same material as the original, but in some cases an alternate material with similar qualities may be appropriate.

### **3.42 Building materials on a primary facade should not be replaced with synthetic materials.**

- Avoid synthetic materials that appear different from that of the original as replacements for primary building materials. Examples are metal, vinyl siding or panelized brick or stone.
- Modular materials should not be used as replacement materials. Synthetic stucco and panelized brick, for example, are inappropriate.

### **3.43 An alternative material that matches the original may be considered.**

- In some instances, substitute materials may be used for replacing architectural details. If a new material is used, its style, finish and detail should match the historic model.
- Green building materials, such as those made with renewable and local resources, may be considered for replacement materials where they will not adversely impact the integrity of a building or its key features.



*Preserve significant stylistic and architectural features.*

## CORNICES, MOLDINGS AND OTHER ARCHITECTURAL DETAILS

Architectural details contribute to the character of a structure and often make up many of its character-defining features. Specific types of details are often closely associated with specific architectural styles. Select an appropriate treatment that will provide for proper preservation of significant features. The method that requires the least intervention is preferred. See the styles section in Chapter I for more information on identifying key features, and Chapter II for more information on determining appropriate treatment strategies for them.

### Treatment of Historic Architectural Details

#### 3.44 Preserve significant stylistic and architectural features.

- Storefronts, cornices, porches, turned columns, brackets, exposed rafter tails and jigsaw ornaments are examples of architectural features that should be preserved.
- Do not remove or alter architectural details that are in good condition or that can be repaired.

#### 3.45 Maintain architectural details in good condition.

- Employ protective measures such as rust removal, caulking, limited paint removal and reapplication of paint. These should not harm the historic materials.
- Regularly check details that have surfaces which can hold moisture for long periods of time.

#### 3.46 Avoid adding details that were not part of the original building.

- For example, decorative millwork should not be added to a building if it was not an original feature. Doing so would convey a false history.

## Options for the Repair of Architectural Details

If a feature is deteriorated or damaged, repair it to its original condition.

### 3.47 Repair deteriorated features.

- Patch, piece-in, splice, consolidate or otherwise upgrade existing materials, using recognized preservation methods.
- Isolated areas of damage may be stabilized or fixed using consolidants. Epoxies and resins may be considered for wood repair.
- Removing a damaged feature that can be repaired is not appropriate.
- Protect significant features that are adjacent to the area being worked on.

### 3.48 When disassembly of a historic element is necessary for its repair, use methods that minimize damage to it.

- When removing a historic feature, document its location so it may be repositioned accurately.

### 3.49 Use technical procedures for cleaning, refinishing and repairing an architectural detail that will maintain the original finish.

- Use the gentlest means possible that will achieve the desired results.

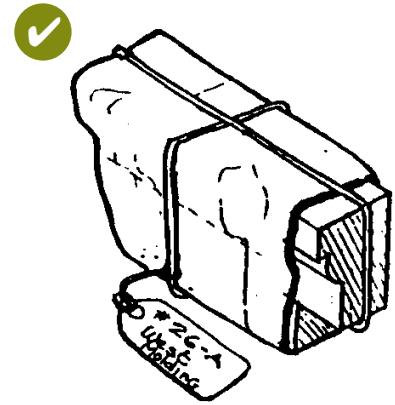

*When disassembly of a historic feature is required in a rehabilitation procedure, document its location so that it may be repositioned accurately.*

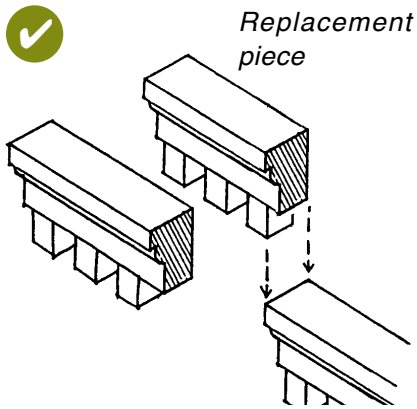

Where replacement of an element is required, remove only those portions that are deteriorated beyond repair.



Replace missing original details in kind.

## Options for Replacement of Architectural Details

If it is not feasible to repair the feature, then replace it with one that is similar in character to the original.

### 3.50 Replace an architectural element accurately.

- Replace only that portion which is beyond repair.
- Base the design on physical or pictorial evidence to assure accuracy.
- Design the replacement piece to be as similar in character to the original as feasible (e.g., materials, detail, finish).
- A substitute material may be acceptable if the size, shape, texture and finish conveys the visual appearance of the original.
- Alternative materials also may be considered in locations that are less visible.

### 3.51 When reconstructing an element is impossible, develop a new design that is a simplified interpretation of it.

- This is appropriate when inadequate information exists to allow for an accurate reconstruction.
- The new element should be similar to comparable features in general size, shape, texture, material and finish. (See page 38 for an illustration of simplified cornice design as an example.)



## SOLUTIONS FOR ADDITIONS TO HISTORIC BUILDINGS

When planning an addition to an existing building, consider the effect it will have on the structure. An addition should be compatible with the primary structure and not detract from one's ability to interpret its historic character.

### **3.52 Minimize the loss of historically significant features when planning an addition.**

- An addition should not damage or obscure architecturally important features. For example, avoid altering a historic cornice or parapet line with an addition.

### **3.53 An addition should be compatible with the main building.**

- An addition should relate to the building in mass, scale, character and form. It should appear subordinate to the main structure.
- The materials, window sizes and alignment of trim elements on an addition should be compatible to those of the existing structure.
- An addition to the front of a building is inappropriate.
- An addition should be simple in design to prevent it from competing with the primary facade.
- Greater flexibility of non-visible facades is appropriate. (See Chapter II for more information on applying flexibility in the treatment of historic properties.)

### **3.54 Minimize the visual impacts of skylights and other rooftop devices.**

- A skylight that is flush with the roof plane may be considered on the rear and sides of the roof.
- The addition of features such as skylights should not interrupt the plane of the historic roof, and should be located below the ridgeline.
- Locate electronic data transmission and receiving devices to minimize impacts to the extent feasible.

## **AUTOMATED TELLER MACHINES (ATMs)**

Automated Teller Machines are features introduced in the late Twentieth Century that were not a part of the original building fabric of historic buildings in Downtown Littleton. As such, they are retrofitted devices, which have the potential to alter the historic character of a building. At the same time, ATMs can help encourage pedestrian activity in the downtown and keep historic buildings in active use. The key is to design an ATM such that it is an asset to a historic building, and any potential negative effects are minimized. While many historic buildings can accommodate an ATM, they may not be appropriate for all buildings.

Special considerations are the use of colors and signs associated with the bank, as well as lighting systems used. It is understood that corporate identity is expressed with unique colors and signs, but to the extent feasible, these should remain subordinate to the overall color scheme of the building materials themselves, while also accomplishing the functional requirements of identifying the ATM device. It is also important to consider the potential for reversibility.

### **3.55 Locate an ATM to minimize impacts on the historic property.**

- Locate an ATM in the least visually prominent position, while providing sufficient access for its use.
- Placing an ATM inside the building is preferred.
- Where it is not feasible to place it internally, locating an ATM on a secondary (side) wall may be considered.
- Locating an ATM on the front of a historic building should be avoided to the extent feasible. However, doing so may be considered only where no other options exist and its impacts will be minimal.
- When placed on an exterior facade, use an alcove or recessed entry to locate the ATM when feasible.

**3.56 Install an ATM to minimize destruction of historic building fabric.**

- A surface mounted device that does not require substantial removal of original building material is preferred.
- Locating it to fit within an existing window opening may be considered, if the window is not original and no loss of historic material would be involved.

**3.57 Use an ATM design that minimizes its visual impacts.**

- Use a small-scale device.
- Use colors that blend with historic building materials to the extent feasible.

**3.58 Use lighting that will be shielded and that focuses on the task area of the ATM.**

- Minimize glare and light spill.



*This infill project in St. Michaels, MD shows an ATM located on a secondary wall. This is an appropriate approach when it is not possible to locate the ATM internally.*

## LOCATING AN ADDITION ON A COMMERCIAL PROPERTY

### Original Building

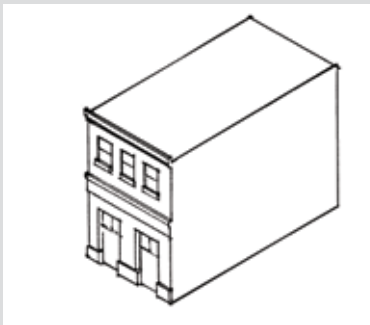

An original two-story building, before an addition. Compare with sketches below.

### Addition to the Side

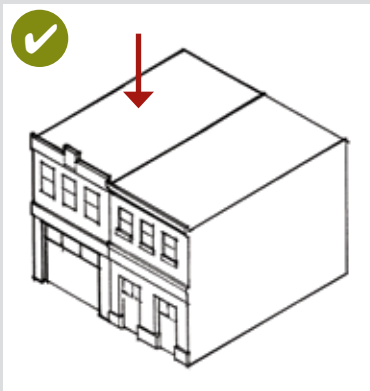

### Roof-Top Addition

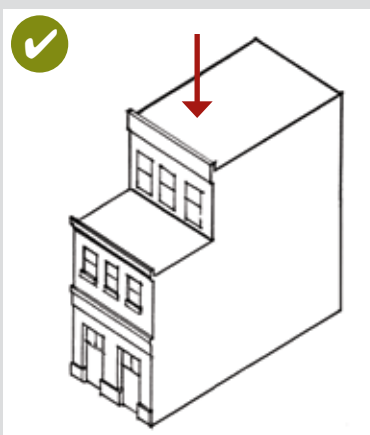

## OPTIONS FOR ADDITIONS TO COMMERCIAL PROPERTIES

Two distinct types of additions to historic commercial buildings may be considered. First, a ground-level addition that involves expanding the footprint of a structure may be considered. Such an addition should be to the rear or side of a building to minimize impact on the character of a building. Second, an addition to the roof may be designed that is simple in character and set back from the front of a building.

### 3.59 An addition may be made to the roof of a commercial building if it does the following:

- Set back an addition from the primary, character-defining facade to be minimally visible from the street and preserve the perception of the building's historic scale. Typically this will be at least a 15 foot setback.
- Its design should be modest in character, so it will not detract attention from the historic facade.
- The addition should be distinguishable as new, while still compatible with the historic structure.

### Roof-top Patios and Terraces

A roof-top patio or terrace should be subordinate to the character of the building and the downtown.

### 3.60 Design a roof-top patio addition to minimize impacts to a historic structure and adjacent properties.

- Set back a patio and any railing from the primary facade to minimize visibility from the street.
- Extending a deck to overhang beyond the building facade is inappropriate.
- Design rooftop areas to minimize impacts to the side-wall of an adjacent building.



This two-story rear and roof-top addition is compatible with, yet remains subordinate to, the original one-story structure.

## OPTIONS FOR ADDITIONS TO RESIDENTIAL PROPERTIES

The most appropriate type of addition to a residential property is to the rear. Side, and in some cases rooftop additions may also be considered where they are set back from the primary facade and are subordinate to the historic structure.

### 3.61 Place a residential addition at the rear of a building or set it back from the front to minimize the visual impacts.

- This will allow the original proportions and character to remain prominent.
- For a larger addition, break up the mass of the addition into smaller modules that relate to the historic house.

### 3.62 A rooftop dormer may be appropriate.

- A dormer should be similar in character to the primary roof form.
- A dormer should be subordinate to the overall roof mass and should be in scale with those on similar historic structures.
- The dormer should be located below the ridge line of the primary structure and to the rear of the roof.
- The number and size of dormers should not visually overwhelm the scale of the primary structure.

## LOCATING AN ADDITION ON A RESIDENTIAL PROPERTY

### Original Building

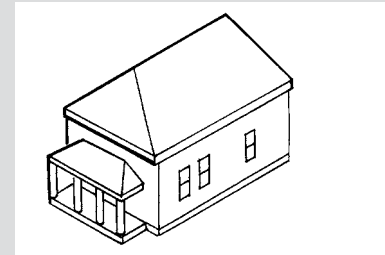

### Appropriate Addition to the Rear



*Addition is set back behind the original and accessed by a connector.*

## LOCATING A DORMER ADDITION



**Original building**



**Small gable dormer**  
*Dormer addition is centered and located below the roof ridge.*



**Full Gable Dormer**  
*Gable overwhelms the facade and alters the character.*



*Certain areas retain a distinct historic residential character, defined by a landscaped front yard and side yard setbacks. Plantings and other landscape features should remain prominent in a historic residential setting.*

## SOLUTIONS FOR HISTORIC SITE FEATURES

The character of a historic building is directly influenced by its site and setting. In some cases site features have historic significance, in others, site design affects one's ability to interpret the historic building and setting. Site work that alters the historic character of a building or the district should be avoided.

### 3.63 Preserve historic site features.

- Maintain existing significant site features such as paving, fencing, walls, light fixtures, etc.
- Repair where necessary.
- Replace only portions that are deteriorated beyond repair. A replacement material should match the original in color, texture, size and finish.

### 3.64 Preserve historically significant planting designs.

- Retain historic planting beds, landscape features and walkways.
- Avoid removing mature, character-defining landscaping unless it is damaged or diseased beyond preservation, or causes a threat to the historic structure.

### 3.65 Avoid new site features which have the potential to damage or interfere with a historic site or structure.

- Design site features to be compatible with the historic character of the building.
- Select plant species according to their mature size to allow for the long-term impact of mature growth.
- Avoid the use of exotic plant species.
- Avoid placing climbing plants too close to a building.

## Front Yard Amenity Space

Certain areas retain a distinct historic residential character, defined by a landscaped front yard and side yard setbacks. To maintain and enhance this tradition in certain areas, a landscaped front yard amenity space may be considered.

### 3.66 Maintain front and side yard amenity space on a historic residential building.

- Plantings and other landscape features should remain prominent at the street front in this setting.

## SOLUTIONS FOR SUSTAINABILITY

This section provides solutions for maintaining and improving resource and energy efficiency in a historic building, as well as methods for approaching energy conservation and generation technologies. Other sustainability guidelines throughout this document will also apply.

### PLANNING A REHABILITATION PROJECT FOR ENERGY EFFICIENCY

Follow these basic steps when considering a rehabilitation project for energy efficiency:

#### Step 1:

#### Establish Project Goals.

Develop an overall strategy and project goals to maximize the effectiveness of a project. Developing overall project goals will establish a broad view that can help place individual actions into context. Project goals should focus on minimizing use of resources and energy, minimizing negative environmental impacts, and retaining the historic integrity of a property. Strategies should maximize the inherent value of the historic resource prior to considering alterations or energy generation technology.

To inform a project strategy, also consider conducting an energy audit. Energy audits can give a comprehensive view of how energy is currently used, in the daily and seasonal cycles of use, and can also provide perspective on the payback of investment for potential work on the building. For example, an energy audit, when examined based on an overall strategy, may demonstrate that priorities should be on increasing insulation in walls, ceilings and foundations, rather than replacing windows.

#### Energy Efficiency Strategy

Follow these basic steps when considering an energy efficiency rehabilitation project:

##### Step 1:

Establish Project Goals.

##### Step 2:

Maintain Building Components in Sound Condition.

##### Step 3:

Maximize Inherent Sustainable Qualities.

##### Step 4:

Enhance Building Performance.

##### Step 5:

Add Energy-Generating Technologies Sensitive.

**Step 2:  
Maintain Building Components in  
Sound Condition.**

Maintaining existing building fabric reduces negative environmental impacts. Re-using a building preserves the energy and resources invested in its construction, and removes the need for producing new construction materials. See page 19 for more information on the environmental benefits of historic preservation.

**Step 3:  
Maximize Inherent Sustainable  
Qualities.**

Typically, historic buildings were built with resource and energy efficiency in mind. Construction methods focused on durability and maintenance, resulting in individual building features that can be repaired if damaged, thus minimizing the use of materials throughout the building's lifecycle. Buildings were also built to respond to local climate conditions, integrating passive and active strategies for year-round interior climate control, which increase energy efficiency. Passive strategies typically include building orientation and features such as roof overhangs and windows to provide both natural daylighting as well as management of solar heat gain. Active strategies typically include operable building features such as awnings and double-hung and transom windows. Identify a building's inherent sustainable features and operating systems and maintain them in good operating condition. In some cases these features may be covered, damaged or missing; repair or restore them where necessary.

**Step 4:  
Enhance Building Performance.**

A historic building's inherent energy efficiency can be augmented using techniques which improve energy efficiency without negatively impacting historic building elements. Non-invasive strategies such as increased insulation, weatherization improvements and landscaping should be considered.



---

## **Step 5: Add Energy-Generating Technologies Sensitive.**

The flexibility of many historic structures allows for the respectful integration of energy efficiency technologies. Energy-generating technologies are the most commonly known strategies. However, the efficiency of a historic structure will often be great enough that generation technologies aren't the most practical solutions. Utilize strategies to reduce energy consumption prior to undertaking an energy generation project.

When integrating modern energy technology into a historic structure, maintain the resource's historic integrity and the ability to interpret its historic significance. As technology and society's understanding of the meaning of sustainability continue to develop, so too will the methods for integrating these technologies with a historic building. As new technologies are tried and tested it is important that they be installed in a reversible manor such that they leave no permanent negative impacts to a historic structure.

**DOUBLE HUNG WINDOW VENTILATION**

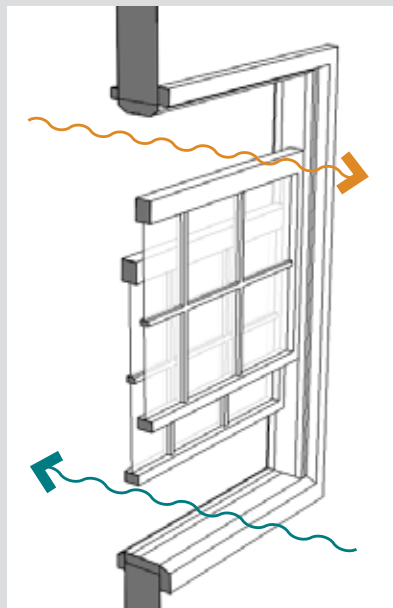

*Double hung windows simultaneously allow for cool air in and warm air out.*

**MAINTAINING THE INHERENT ENERGY EFFICIENCY OF A HISTORIC BUILDING**

Original sustainable building features and systems should be maintained in good operating condition in an energy efficiency rehabilitation project.

**3.67 Preserve the inherent energy efficiency of the original building.**

- Identify a building’s inherent sustainable features and operating systems and maintain them in good condition.
- Repair or restore covered, damaged or missing features where appropriate.
- See pages 8 and 60 for more information on identifying these features.

**3.68 Maintain a building’s sustainability features in operable condition.**

- Retain original shutters, awnings and transoms. Operable features such as these will increase the range of conditions in which a building is comfortable without mechanical climate controls.
- Repair or restore covered, damaged or missing features where necessary.
- See the guidelines for awnings on page 39.

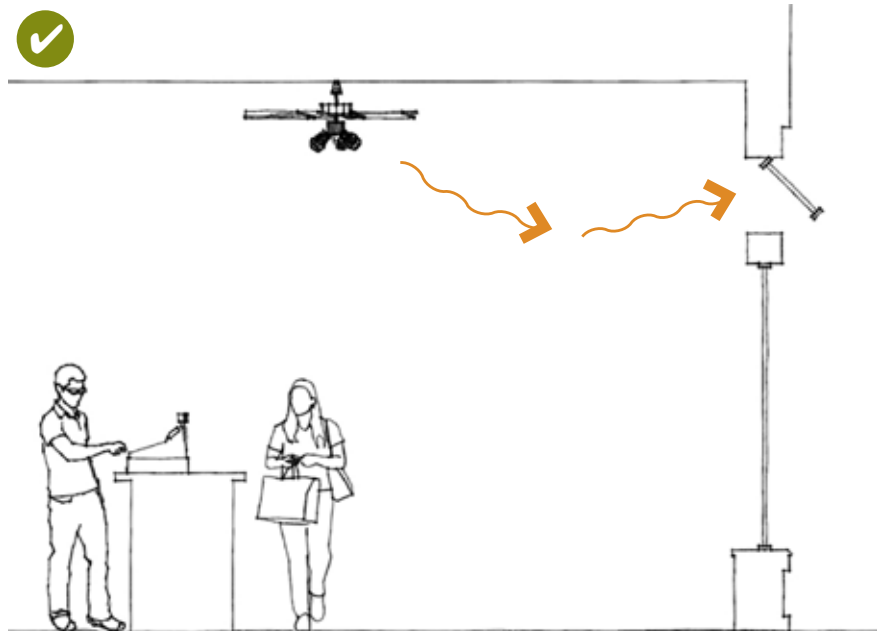

*Maintaining operable transom windows on a historic commercial building preserves both its historic character as well as its inherent energy-efficient advantages.*

## OPTIONS FOR ENHANCING ENERGY PERFORMANCE IN HISTORIC STRUCTURES

Improvements to enhance energy efficiency should be planned to complement the original building. The structure, form and materials should be sensitively improved in energy efficiency terms to preserve the building's character.

### **3.69 Use non-invasive strategies when applying weatherization improvements.**

- Weatherstripping, insulation and storm windows are energy efficient, cost effective, and historically sensitive approaches.
- Weatherstrip original framework on windows and doors.
- Install additional insulation in an attic, basement or crawlspace as a simple method to make a significant difference in a building's energy efficiency. Provide sufficient ventilation to avoid moisture build-up in the wall cavity.
- Where applicable, install draft stoppers in a chimney. Open chimney dampeners can increase energy costs by up to 30 percent.
- Install weatherization strategies in a way that avoids altering or damaging significant materials and their finishes.
- Use materials which are environmentally friendly and that will not interact negatively with historic building materials.



*Design site and landscape improvements to promote energy efficiency where appropriate. In this example deciduous landscaping provides summer shading.*

**3.70 Enhance the energy efficiency of original windows and doors.**

- Make best use of original windows; keep them in good repair and seal all leaks.
- Safeguard, retain and reuse early glass, taking special care in putty replacement.
- Maintain the glazing compound regularly. Remove old putty with care.
- Use operable systems to enhance performance of original windows. This includes storm windows, insulated coverings, curtains and awnings.
- Place storm windows internally when feasible to avoid the impact upon external appearance.
- Use storm window inserts designed to match the original frame if placed externally.
- Double pane glazing may be acceptable where original glazing has been lost and the frame can support the weight and profile. A storm window is still more efficient however.

**3.71 Design site and landscape improvements to promote energy efficiency where appropriate.**

- Where a site includes landscaping, use drought tolerant plants to reduce the need for irrigation.
- Plant trees or shrubbery to serve as windbreaks and provide seasonal shading.

**3.72 Avoid adverse impacts to a historic commercial building when installing a green roof.**

- A green roof provides thermal mass to help regulate internal temperature, as well as helps to reduce the urban heat island effect.
- Green roof material should not replace significant roofing materials.
- The weight of the green roof should not threaten the structural integrity of the building. If additional structural support is needed for installation of the roof, it should only be considered where adverse impact to the building’s historic significance can be avoided.

## SOLUTIONS FOR ENERGY GENERATING TECHNOLOGIES

When integrating modern energy technology into a historic structure, maintain the resource's historic integrity and the ability to interpret its historic significance. Use of energy-generating technologies should be the final option considered in an efficiency rehabilitation project. Utilize strategies to reduce energy consumption prior to undertaking an energy generation project. Consider the overall project goals and energy strategies when determining if a specific technology is appropriate for your project.

As new technologies are tried and tested, it is important that they leave no permanent negative impacts to historic structures. The reversibility of their application will be a key consideration when determining appropriateness.

### **3.73 Locate technology to minimize impacts to the historic character of the building.**

- Locate technology where it will not damage, obscure or cause removal of significant features or materials.
- Maintain the ability to interpret the historic character of the building.

### **3.74 Install new technology in a reversible manner.**

- Install technology in such a way that it can be readily removed and the original character easily restored.
- Use materials which are environmentally friendly and that will not interact negatively with historic building materials.

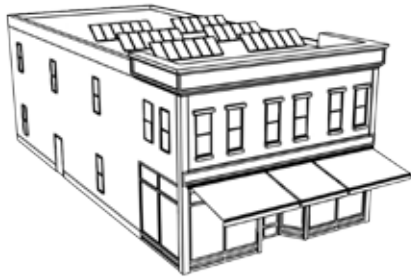

*Place collectors to avoid obscuring significant features or adversely affecting the perception of the overall character of the property.*



*Mount collectors flush below the ridgeline on a sloping roof.*



*Attach solar collectors to a historic roof in a minimally invasive and reversible manner. In this example the panels are mounted such that the original shingles are saved.*

## Solutions for Specific Technologies

### Solutions for Solar Collectors

Solar collectors should be designed, sized and located to minimize their effect on the character of a historic building.

#### 3.75 Minimize adverse effects from solar collectors on the character of a historic building.

- Place collectors to avoid obscuring significant features or adversely affecting the perception of the overall character of the property.
- Size collector arrays to remain subordinate to the historic structure.
- Minimize visual impacts by locating collectors back from the front facade.
- Mount collectors flush below the ridgeline on a sloping roof. This will not cause a significant decrease in the device's solar gain capabilities.
- Consider installing collectors on an addition or secondary structure where applicable.
- Exposed hardware, frames and piping should have a matte finish, and be consistent with the color scheme of the primary structure.

#### 3.76 Use the least invasive method feasible to attach solar collectors to a historic roof.

- Avoid damage to significant features.
- Install a collector in such a way that it can be removed and the original character easily restored.
- Collector arrays should not threaten the structural integrity of the building.

#### 3.77 Consider using building-integrated photovoltaic technology where the use of new building material is appropriate.

- Installing integrated photovoltaic systems should be planned where they will not hinder the ability to interpret the historic significance of the structure. For example, solar shingles on a rear or secondary roof facade where the original roof material is missing or significantly damaged would be appropriate.

### Solutions for Wind Power

Small-scale wind generators can provide supplementary energy supply in some areas. The siting of wind turbine equipment should take advantage of screening provided by vegetation and mature tree cover as well as the grouping of existing buildings. Minimizing impacts to the historic character of a building as well as to the downtown district should be the primary consideration.



*Design the scale and location of a turbine to remain subordinate to the historic structure.*

#### **3.78 Minimize the visual impacts of a wind turbine from primary public view locations.**

- Turbines should not obscure significant features or impair the ability to interpret the building's historic significance.
- The turbine and any exposed hardware should have a matte finish, and be consistent with the color scheme of the primary structure.
- Design the scale and location of the turbine to remain subordinate to the historic structure.

#### **3.79 Install turbines in such a way that can be readily removed.**

- Attach turbines in a manner that avoids damage to significant features.
- The original condition of the building should be easily restored.

#### **3.80 Minimize structural impacts when installing turbines.**

- Install turbines as freestanding structures in unobtrusive locations when feasible.
- When attaching to the building, turbines should not overload structural systems, or threaten the integrity of roof protection systems.

### Passive Energy Collection Systems

Passive systems typically include designs to capture and retain heat from the sun in the mass of the building to minimize indoor temperature swings. For historic buildings, these are difficult to construct as a part of the original building without significantly changing the character of an exterior wall. However, they may work successfully in an addition when placed in a position that is less visible.

#### 3.81 Locating a passive system in an unobtrusive location.

- Installation on a new wing or addition is preferred.

#### 3.82 Minimize adverse effects from a passive collection system on the character of a historic building.

- Avoid damaging or obscuring significant features or materials.
- Minimize structural impacts to the building.
- Use materials that appear similar to those seen traditionally in the area to the maximum extent feasible.
- Consider visual impacts on traditional ratios of windows to solid walls that are seen in the historic district when large window areas are needed.

## LOCATING A PASSIVE SOLAR WALL ON A HISTORIC BUILDING



### Existing Building with Rear Addition

#### Option 1: Connector Wall



Locate a trombe wall on connector wall when:

- The building is highly significant
- The context has many intact historic buildings
- The connector wall is not highly visible

#### Option 2: Rear Addition



Locate a trombe wall on rear addition when:

- The lot depth is not sufficient to allow a large enough connector for the trombe
- Site constraints restrict solar access
- Rear wall is not highly visible

#### Inappropriate Location



It is inappropriate to locate a trombe wall on the historic structure where a new addition exists.



## COMMERCIAL BUILDING ENERGY EFFICIENCY DIAGRAM

This diagram summarizes the principal direction in the guidelines for a rehabilitation project for energy efficiency on a commercial building. These measures can enhance energy efficiency while retaining the integrity of the historic structure.

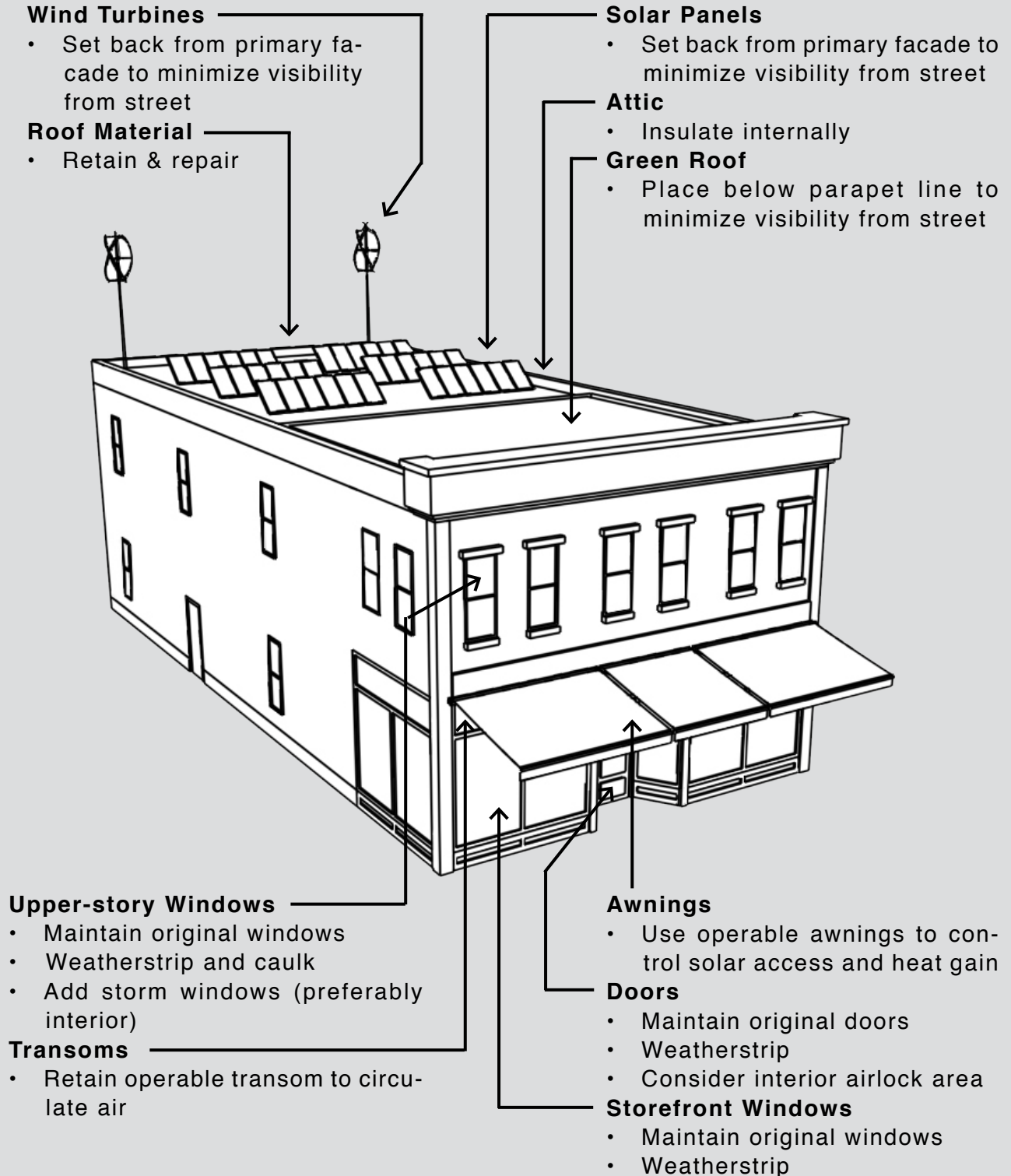

## RESIDENTIAL BUILDING ENERGY EFFICIENCY DIAGRAM

This diagram summarizes the principal direction in the guidelines for a rehabilitation project for energy efficiency on a residential building. These measures can enhance energy efficiency while retaining the integrity of the historic structure.

### Chimney

- Install draft stopper

### Attic

- Insulate internally

### Roof Material

- Retain & repair

### Solar Panels

- Set back from primary facade

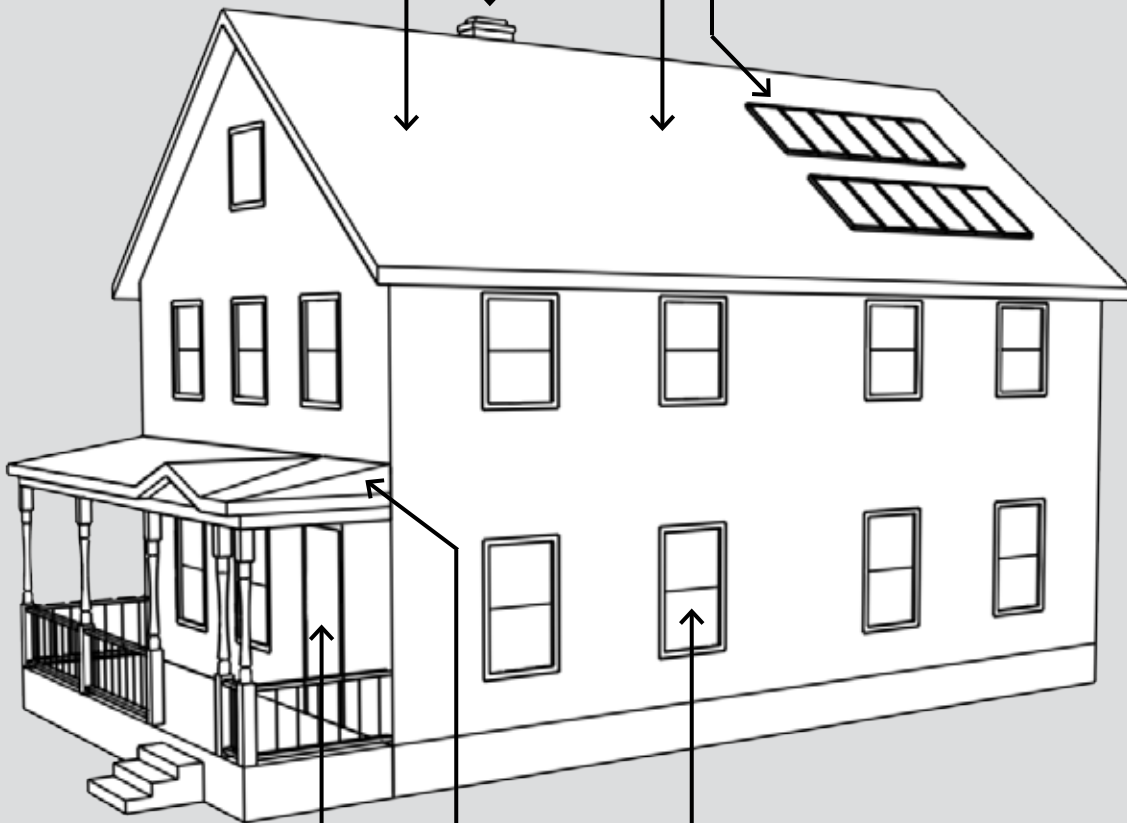

### Doors

- Retain & repair original or early doors
- Weatherstrip

### Shutters, Awnings & Porches

- Restore porches and awnings

### Windows

- Repair & retain original or early windows
- Retain original glass
- Enhance thermal & acoustic efficiency with storm windows (preferably interior)
- Weatherstrip